

# NINJA®

## Foodi® Dual Zone Air Fryer

# AF300UK

## INSTRUCTIONS



# THANK YOU

for purchasing the Ninja® Foodi® Dual Zone Air Fryer



## REGISTER YOUR PURCHASE

 [ninjakitchen.co.uk/register-guarantee](https://ninjakitchen.co.uk/register-guarantee)

 Scan QR code using mobile device

## RECORD THIS INFORMATION

Model Number: \_\_\_\_\_

Serial Number: \_\_\_\_\_

Date of Purchase: \_\_\_\_\_  
(Keep receipt)

Store of Purchase: \_\_\_\_\_

## TECHNICAL SPECIFICATIONS

Voltage: 220-240V~, 50-60Hz

Watts: 2470W

**TIP:** You can find the model and serial numbers on the QR code label on the back of the unit by the power cord.

# CONTENTS

<b>Product Registration</b> .....	<b>2</b>
<b>Important Safeguards</b> .....	<b>3</b>
<b>Parts</b> .....	<b>5</b>
<b>Getting to Know Your Dual Zone Air Fryer</b> .....	<b>6</b>
Function Buttons .....	6
Operating Buttons .....	6
<b>Before First Use</b> .....	<b>6</b>
<b>Using Your Dual Zone Air Fryer</b> .....	<b>7</b>
Cooking with DualZone Technology .....	7
Cooking in a single zone .....	9
Max Crisp .....	9
Air Fry .....	10
Roast .....	11
Reheat .....	11
Dehydrate .....	12
Bake .....	12
<b>Cleaning &amp; Maintenance</b> .....	<b>13</b>
<b>Helpful Tips</b> .....	<b>13</b>
<b>Troubleshooting Guide</b> .....	<b>14</b>

## PRODUCT REGISTRATION

Please visit [registeryourninja.co.uk](https://registeryourninja.co.uk) or call 0800 862 0453 to register your new Ninja® product within 28 days of purchase. You will be asked to provide the store name, date of purchase, and model number along with your name and address.

The registration will enable us to contact you in the unlikely event of a product safety notification. By registering, you acknowledge you have read and understood the instructions for use and warnings set forth in the accompanying instructions.

# IMPORTANT SAFEGUARDS

## HOUSEHOLD USE ONLY

Read all instructions before using your Ninja® Foodi® Dual Zone Air Fryer.

When using electrical appliance, basic safety precautions should always be followed, including the following:

## ⚠ WARNINGS

- 1** This appliance can be used by persons with reduced physical, sensory or mental capabilities or lack of experience and knowledge if they have been given supervision or instruction concerning use of the appliance in a safe way and understand the hazards involved.
- 2** Keep the appliance and its cord out of reach of children. **DO NOT** allow the appliance to be used by children. Close supervision is necessary when used near children
- 3** Children should not play with the appliance.
- 4** **DO NOT** place or store anything on top of product when in use.
- 5** **DO NOT** place appliance on hot surfaces or near a hot gas or electric burner, on or in a heated oven or stovetop.
- 6** **NEVER** use electrical socket below counter.
- 7** **NEVER** connect this appliance to an external timer switch or separate remote-control system.
- 8** **DO NOT** use an extension cord. A short power-supply cord is used to reduce the risk of children less than 8 years grabbing the cord or becoming entangled and to reduce the risk of people tripping over a longer cord.
- 9** To protect against electrical shock **DO NOT** immerse cord, plugs, or main unit housing in water or other liquid. Cook only in the drawer provided.
- 10** Regularly inspect the appliance and power cord. **DO NOT** use the appliance if there is damage to the power cord or plug. If the appliance malfunctions or has been damaged in any way, immediately stop use and call Customer Service.
- 11** **ALWAYS** ensure the appliance is properly assembled before use.
- 12** **DO NOT** cover the air intake vent or air outlet while unit is operating. Doing so will prevent even cooking and may damage the unit or cause it to overheat.
- 13** Before placing removable drawer into the main unit, ensure drawer and unit are clean and dry by wiping with a soft cloth.
- 14** This appliance is for household use only. **DO NOT** use this appliance for anything other than its intended use. **DO NOT** use in moving vehicles or boats. **DO NOT** use outdoors. Misuse may cause injury.
- 15** Intended for worktop use only. Ensure the surface is level, clean and dry. **DO NOT** move the appliance when in use.
- 16** **DO NOT** place the appliance near the edge of a worktop during operation.
- 17** **DO NOT** use accessory attachments not recommended or sold by SharkNinja. Do not place accessories in a microwave, toaster oven, convection oven, or conventional oven or on a ceramic cooktop, electric coil, gas burner range or outdoor grill. The use of accessory attachments not recommended by SharkNinja may cause fire, electric shock or injuries.
- 18** **ALWAYS** ensure drawer is properly closed before operating.
- 19** When using this appliance, provide adequate space above and on all sides for air circulation.
- 20** **DO NOT** use the appliance without the removable drawer installed.
- 21** **DO NOT** use this appliance for deep-frying.

- 22** Prevent food contact with heating elements. **DO NOT** overfill when cooking. Overfilling may cause personal injury or property damage or affect the safe use of the appliance.
- 23** Socket voltages can vary, affecting the performance of your product. To prevent possible illness, use a thermometer to check that your food is cooked to the temperatures recommended.
- 24** Should the unit emit black smoke, unplug immediately. Wait for smoking to stop before removing any cooking accessories.
- 25** **DO NOT** touch hot surfaces. Appliance surfaces are hot during and after operation. To prevent burns or personal injury, **ALWAYS** use protective hot pads or insulated oven mitts and use available handles.
- 26** Extreme caution must be used when the appliance contains hot food. Improper use may result in personal injury.
- 27** Spilled food can cause serious burns. Keep appliance and cord away from children. **DO NOT** let cord hang over edges of tables or counters or touch hot surfaces.
- 28** The drawer and crisper plate become extremely hot during the cooking process. Avoid physical contact while removing the drawer or plate from the appliance. **ALWAYS** place drawer or plate on a heat-resistant surface after removing. **DO NOT** touch accessories during or immediately after cooking.
- 29** Cleaning and user maintenance should not be carried out by children.
- 30** To disconnect, turn off any control to OFF, then unplug from socket when not in use and before cleaning. Allow to cool before cleaning, disassembly, putting in or taking off parts and storage.
- 31** **DO NOT** clean with metal scouring pads. Pieces can break off the pad and touch electrical parts, creating the risk of electric shock.
- 32** Please refer to the Cleaning & Maintenance section for regular maintenance of the appliance.



Indicates to read and review instructions to understand operation and use of product.



Indicates the presence of a hazard that can cause personal injury, death or substantial property damage if the warning included with this symbol is ignored.



Take care to avoid contact with hot surface. Always use hand protection to avoid burns.



For indoor and household use only.

## SAVE THESE INSTRUCTIONS

## PARTS

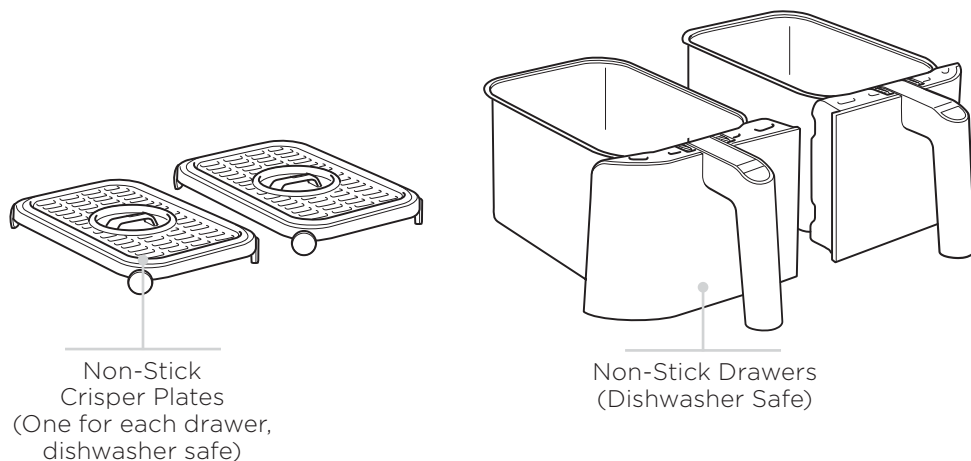
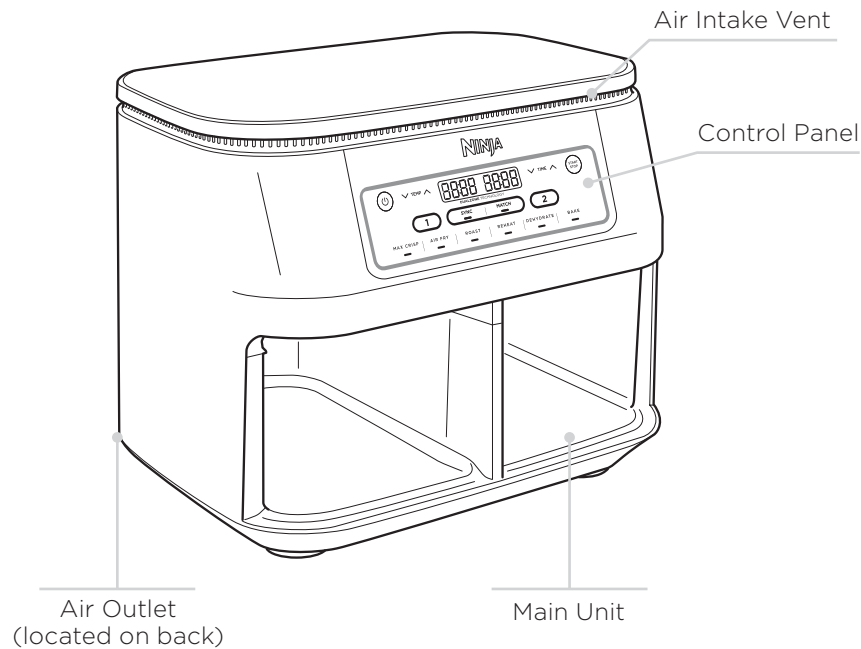

## GETTING TO KNOW YOUR AIR FRYER

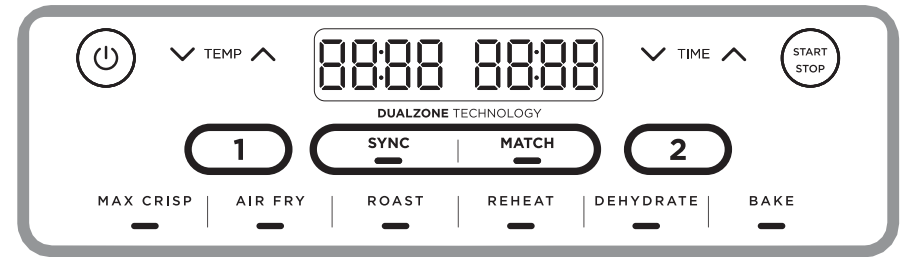

When setting time, the digital display shows HH:MM.

### FUNCTION BUTTONS

**MAX CRISP:** Best for frozen foods such as French fries and chicken nuggets.

**AIR FRY:** Use this function to give your food crispiness and crunch with little to no oil.

**ROAST:** Use the unit as an oven for tender meats and more.

**REHEAT:** Revive leftovers by gently warming them, leaving you with crispy results.

**DEHYDRATE:** Dehydrate meats, fruits and vegetables for healthy snacks.

**BAKE:** Create decadent baked treats and desserts.

### OPERATING BUTTONS

- ① Control the output for the drawer on the left (Zone 1).
- ② Control the output for the drawer on the right (Zone 2).

**TEMP arrows:** Use the up and down arrows to adjust the cook temperature before or during cooking.

**TIME arrows:** Use the up and down arrows to adjust the cook time in any function before or during the cook cycle

**SYNC button:** Automatically syncs the cook times to ensure both zones finish at the same time, even if they have different cook times.

**MATCH button:** Automatically matches zone 2 settings to those of zone 1 to cook a larger amount of the same food, or cook different foods using the same function, temperature, and time.

**START/STOP button:** After selecting temperature and time, start cooking by pressing the START/STOP button.

**Power button:** The  button turns the unit on, and also shuts it off and stops all cooking functions.

**STANDBY MODE:** After 10 minutes with no interaction with the control panel, the unit will enter standby mode.

**HOLD MODE:** Hold will appear on the unit while in SYNC mode. One zone will be cooking, while the other zone will be holding until the times sync together.

## BEFORE FIRST USE

- 1 Remove and discard any packaging material, promotional labels, and tape from the unit.
- 2 Remove all accessories from the package and read this manual carefully. Please pay particular attention to operational instructions, warnings, and important safeguards to avoid any injury or property damage.
- 3 Wash the drawers and crisper plates in hot, soapy water, then rinse and dry thoroughly. The drawers and crisper plates are the **ONLY** dishwasher safe parts. However to extend the life of the drawers we recommend hand-washing. **NEVER** clean the main unit in the dishwasher.

# COOKING IN YOUR AIR FRYER

## REFERENCE QUICK START GUIDE FOR RECIPES AND COOKING CHARTS

### COOKING WITH DUALZONE TECHNOLOGY

DualZone Technology utilises two cooking zones to increase versatility. The Sync feature ensures that, regardless of different cook settings, both zones will finish ready to serve at the same time.

For detailed instructions on using each function, see pages 9-12.

### SYNC

To finish cooking at the same time when foods have different cook times, temps, or even functions:

- 1 Place ingredients in the drawers, then insert drawers in unit.
- 2 Zone 1 will remain illuminated. Select the desired cooking function. Use the TEMP arrows to set the temperature, and use the TIME arrows to set the time.



- 3 Select zone 2, then select the desired cooking function. Use the TEMP arrows to set the temperature, and use the TIME arrows to set the time.



**NOTE:** You can select a different function for zone 2.

- 4 Press SYNC, then press the START/STOP button to begin cooking in the zone with the longest time. The other zone will display **Hold**. The unit will beep and activate the second zone when both zones have the same time remaining.



**NOTE:** If you decide the food in one of the zones is done cooking before the cook time is up, you can **STOP A ZONE**. Select that zone, then press START/STOP. See page 9 for further instructions.

- 5 When cooking is complete, the unit will beep and "End" will appear on the display.

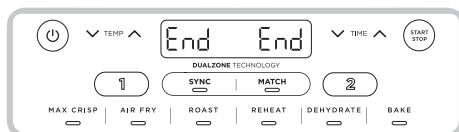

- 6 Remove ingredients by tipping them out or using silicone-tipped tongs/utensils. **DO NOT** place drawer on top of unit.

### MATCH

To cook a larger amount of the same food, or cook different foods using the same function, temperature, and time:

- 1 Place ingredients in the drawers, then insert drawers in unit.
- 2 Zone 1 will remain illuminated. Select the desired cooking function. Use the TEMP arrows to set the temperature, and use the TIME arrows to set the time.

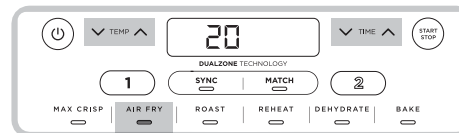

- 3 Press the MATCH button to copy the zone 1 settings to zone 2. Then Press START/STOP to begin cooking in both zones.

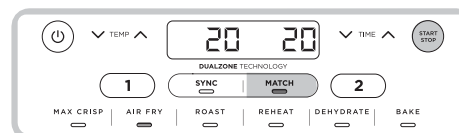

- 4 "End" will appear on both screens when cooking ends at the same time.

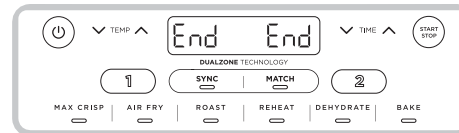

- 5 Remove ingredients by tipping them out or using silicone-tipped tongs/utensils.

### Starting both zones at the same time, but ending at different times:

- 1 Select zone 1, then select the desired function. Use the TEMP arrows to set the temperature.



- 2 Use the TIME arrows to set the time.

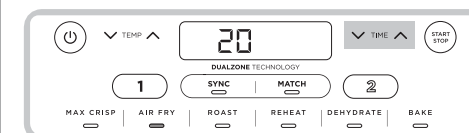

- 3 Select zone 2 and repeat steps 1 and 2.

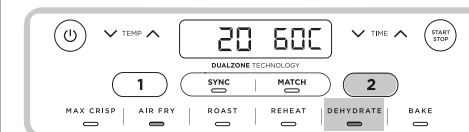

- 4 Press the START/STOP button to begin cooking in both zones.



**NOTE:** If you decide the food in one of the zones is done cooking before the cook time is up, you can **STOP A ZONE**. Select that zone, then press START/STOP. See page 9 for further instructions.

- 5 When cooking is complete in each zone, the unit will beep and "End" will appear on the display.
- 6 Remove ingredients by tipping them out or using silicone-tipped tongs/utensils.

# COOKING IN YOUR AIR FRYER - CONT.

## ENDING THE COOK TIME IN ONE ZONE (WHILE USING BOTH ZONES)

- 1 Select the zone you would like to stop.



- 2 Press START/STOP to end cooking.



- 3 "End" will appear on the display. Cooking will continue in the other zone.



## PAUSING COOKING

Cooking will automatically pause when a drawer is removed. Re-insert drawer to resume cooking.

## WHEN USING IN SYNC or MATCH MODE

If you open a drawer, the other drawer will automatically pause so that cooking will still finish at the same time. Reinsert drawer to continue cooking in both zones.

**NOTE:** If during cooking a drawer is removed for longer than 1 minute, then the unit will automatically switch off. You will need to re-program each zone to resume cooking.

## COOKING IN A SINGLE ZONE

To turn on the unit, plug the power cord into a wall socket, then press the power button.

### Max Crisp

- 1 Install crisper plate in the drawer, then place ingredients in the drawer, and insert drawer in unit.

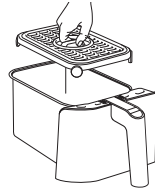

- 2 The unit will default to zone 1 (to use zone 2 instead, select zone 2). Select MAX CRISP.



- 3 Use the TIME arrows to set the time in 1-minute increments up to 30 minutes. Press the START/STOP button to begin cooking.

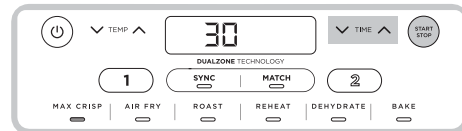

- 4 When cooking is complete, the unit will beep and "End" will appear on the display.

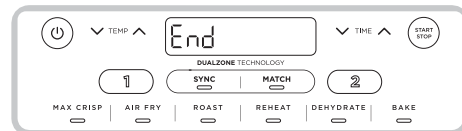

- 5 Remove ingredients by tipping them out or using silicone-tipped tongs/utensils.

## Air Fry

- 1 Install crisper plate in the drawer, then place ingredients in the drawer, and insert drawer in unit.

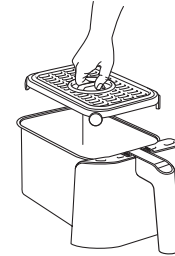

- 2 The unit will default to zone 1 (to use zone 2 instead, select zone 2). Select AIR FRY.



- 3 Use the TEMP arrows to set the desired temperature.



- 4 Use the TIME arrows to set the time in 1-minute increments up to 1 hour. Press the START/STOP button to begin cooking.

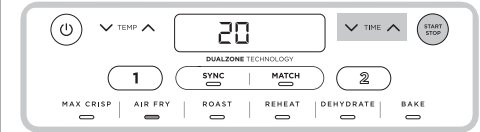

**NOTE:** During cooking, you can remove the drawer and shake or toss ingredients for evening crisping.

- 5 When cooking is complete, the unit will beep and "End" will appear on the display.

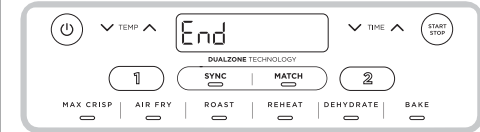

- 6 Remove ingredients by tipping them out or using silicone-tipped tongs/utensils.

# COOKING IN YOUR AIR FRYER - CONT.

## Roast

- 1 Install crisper plate in the drawer (optional), then place ingredients in the drawer and insert drawer in unit.



- 2 The unit will default to zone 1 (to use zone 2 instead, select zone 2). Select ROAST.



- 3 Use the TEMP arrows to set the desired temperature.



- 4 Use the TIME arrows to set the time in 1-minute increments up to 1 hour and in 5-minute increments from 1 to 4 hours. Press the START/STOP button to begin cooking.

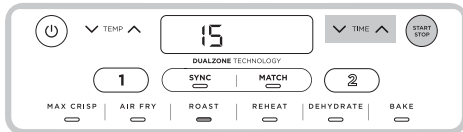

- 5 When cooking is complete, the unit will beep and "End" will appear on the display.

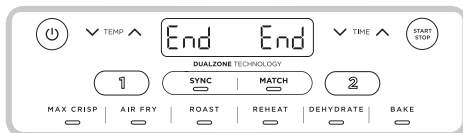

- 6 Remove ingredients by tipping them out or using silicone-tipped tongs/utensils.

## Reheat

- 1 Install crisper plate in the drawer (optional), then place ingredients in the drawer, and insert drawer in unit.

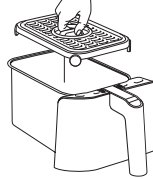

- 2 The unit will default to zone 1 (to use zone 2 instead, select zone 2). Select REHEAT.



- 3 Use the TEMP arrows to set the desired temperature.



- 4 Use the TIME arrows to set the time in 1-minute increments up to 1 hour. Press the START/STOP button to begin reheating.

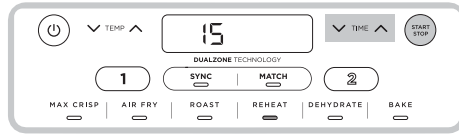

- 5 When reheating is complete, the unit will beep and "End" will appear on the display.

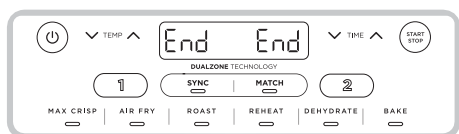

- 6 Remove ingredients by tipping them out or using silicone-tipped tongs/utensils.

## Dehydrate

- 1 Place a single layer of ingredients in the drawer. Then install the crisper plate in the drawer on top of the ingredients and place another layer of ingredients on the crisper plate.
- 2 The unit will default to zone 1 (to use zone 2 instead, select zone 2). Select DEHYDRATE. The default temperature will appear on the display. Use the TEMP arrows to set the desired temperature.

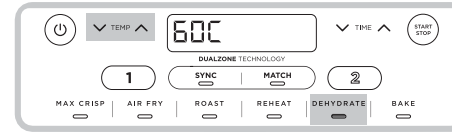

- 3 Use the TIME arrows to set the time in 15-minute increments from 1 to 12 hours. Press the START/STOP button to begin dehydrating.

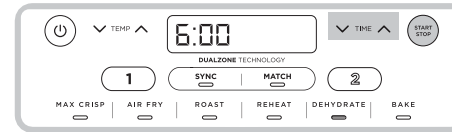

- 4 When cooking is complete, the unit will beep and "End" will appear on the display.

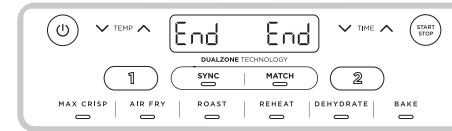

- 5 Remove ingredients by tipping them out or using silicone-tipped tongs/utensils.

## Bake

- 1 Install crisper plate in the drawer (optional), then place ingredients in the drawer and insert drawer in unit.



- 2 The unit will default to zone 1 (to use zone 2 instead, select zone 2). Select BAKE.



**NOTE:** To convert recipes from a traditional oven, reduce the temperature by 10°C.

- 3 Use the TEMP arrows to set the desired temperature.



- 4 Use the TIME arrows to set the time in 1-minute increments up to 1 hour and in 5-minute increments from 1 to 4 hours. Press the START/STOP button to begin cooking.

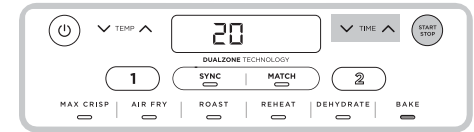

- 5 When cooking is complete, the unit will beep and "End" will appear on the display.

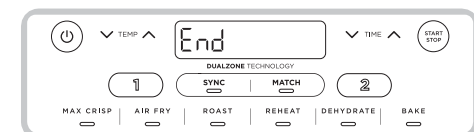

- 6 Remove ingredients by tipping them out or using silicone-tipped tongs/utensils.

## CLEANING & MAINTENANCE

The unit should be cleaned thoroughly after every use. Unplug the unit from the plug socket and wait until the unit is fully cooled before cleaning.

Part/Accessory	Cleaning Method	Dishwasher Safe?
Main Unit	To clean the main unit and the control panel, wipe them clean with a damp cloth <b>NOTE: NEVER</b> immerse the main unit in water or any other liquid. <b>NEVER</b> clean the main unit or drawer in a dishwasher.	No
Drawers and Crisper Plates	These can be washed in the dishwasher or by hand. If handwashed Air-dry or towel-dry all parts after use. To extend the life of the drawers we recommend hand-washing them.	Yes

If food residue is stuck on the crisper plates or drawers, place them in a sink filled with warm, soapy water and allow to soak.

## HELPFUL TIPS

- For consistent browning, make sure ingredients are arranged in an even layer on the bottom of the drawer with no overlapping. If ingredients are overlapping, make sure to shake them halfway through the set cook time.
- Cook temperature and time can be adjusted at any time during cooking. Simply select the zone you want to adjust, then press the TEMP arrows to adjust the temperature or the TIME arrows to adjust the time.
- To convert recipes from your conventional oven, reduce the temperature by 10°C. Check food frequently to avoid overcooking.
- Occasionally, the fan from the air fryer will blow lightweight foods around. To alleviate this, secure foods (like the top slice of bread on a sandwich) with cocktail sticks.
- The crisper plates elevate ingredients in the drawers so air can circulate under and around ingredients for even, crisp results.
- After selecting a cooking function, you can press the START/STOP button to begin cooking immediately. The unit will run at the default temperature and time.
- For best results with fresh vegetables and potatoes, use at least 1 tablespoon of oil. Add more oil as desired to achieve the preferred level of crispiness.
- For best results, check progress throughout cooking and remove food when desired level of brownness has been achieved. We recommend using an instant-read thermometer to monitor the internal temperature of meat & fish. After the cook time is complete, remove food immediately to avoid overcooking.
- For best results, remove food immediately after the cook time is complete to avoid overcooking.

## TROUBLESHOOTING GUIDE

- How do I adjust the temperature or time while using a single zone?**  
Select the active zone, then use the TEMP arrows to adjust the temperature or the TIME arrows to adjust the time.
- How do I adjust the temperature or time while using dual zones?**  
Select the desired zone, then use the TEMP arrows to adjust the temperature or the TIME arrows to adjust the time.
- Does the unit need to pre-heat?**  
The unit does not need to be pre-heated.
- Can I cook different foods in each zone and not worry about cross contamination?**  
Yes, both zones are self-contained with separate heating elements and fans.
- How do I pause the countdown?**  
The countdown timer will pause automatically when you remove the drawers from the unit. Reinsert drawer within 2 minutes to resume cooking or the unit will automatically switch off.
- How do I stop one zone when using both zones?**  
To stop one zone, first press the zone button then press START/STOP. To stop both zones simply press the START/STOP button.
- Is the drawer safe to put on my worktop?**  
The drawer will heat up during cooking. Use caution when handling, and place on heat resistant surfaces only.
- When should I use the crisper plate?**  
Use the crisper plate when you want food to come out crispy. The plate elevates the food in the drawer so that air can flow under and around it to cook ingredients evenly.
- Why didn't my food cook fully?**  
Make sure the drawer is fully inserted during cooking. For consistent browning, make sure ingredients are arranged in an even layer on the bottom of the drawer with no overlapping. Shake drawer to toss ingredients for even crispiness. Cook temperature and time can be adjusted at any time during cooking. Simply use the TEMP arrows to adjust the temperature or the TIME arrows to adjust the time.
- Why is my food burned?**  
For best results, check progress throughout cooking and remove food when desired level of brownness has been achieved. Remove food immediately after the cook time is complete to avoid overcooking.
- Why do some ingredients blow around when air frying?**  
Occasionally, the fan from the air fryer will blow lightweight foods around. Use wooden cocktail sticks to secure loose lightweight food, like the top slice of bread on a sandwich.
- Can I air fry wet, battered ingredients?**  
Yes, but use the proper breading technique. It is important to coat foods first with flour, then with egg, and then with bread crumbs. Press breading firmly onto the battered ingredients, so crumbs won't be blown off by the fan.
- Why is the unit beeping?**  
The food is done cooking or indicates that the other zone started cooking.
- Why did the display screen go black?**  
The unit is in standby mode. Press the power @ button to turn it back on.
- Why is there an "E" message on the display screen?**  
The unit is not functioning properly. Please contact Customer Service at 0800 862 0453.



VISIT US ONLINE AT:

ninjakitchen.co.uk

Or follow us on any of our social media pages:



**NOTE:** Save these instructions. Keep for future reference.



This marking indicates this product should not be disposed of with other household wastes throughout the EU. To prevent possible harm to the environment or human health from uncontrolled waste disposal, recycle it responsibly to promote the sustainable reuse of material sources. To return your used device, please use the return and collection systems or contact the retailer where this product was purchased. They can take this product for environmentally safe recycling.

**Euro-Pro Europe Limited**  
**3150 Century Way**  
**Thorpe Park, Leeds**  
**LS15 8ZB, UK**  
**0800 862 0453**  
**ninjakitchen.co.uk**

Illustrations may differ from actual product. We are constantly striving to improve our products, therefore the specifications contained herein are subject to change without notice.

FOODI and NINJA are registered trademarks of SharkNinja Operating LLC.

© 2020 SharkNinja Operating LLC  
AF300UK\_Series\_30\_IB\_MP\_Mv2\_200414  
PRINTED IN CHINA

