



User Guide

Quality, Design and Innovation



















home.liebherr.com/fridge-manuals





LIEBHERR



Contents

| | | |
|---|---|----------|
| 1 | Appliance at a glance..... | 3 |
| 1.1 | Scope of delivery..... | 3 |
| 1.2 | Overview of the appliance and features..... | 3 |
| 1.3 | Appliance range of use..... | 3 |
| 1.4 | Conformity..... | 4 |
| 1.5 | EPREL database..... | 4 |
| 2 | General safety instructions..... | 4 |
| 3 | Putting into operation..... | 5 |
| 3.1 | Switching on appliance..... | 5 |
| 3.2 | Inserting the components..... | 6 |
| 4 | Foods management..... | 6 |
| 4.1 | Storing food..... | 6 |
| 4.2 | Storage times..... | 6 |
| 5 | Saving energy..... | 6 |
| 6 | Controls..... | 6 |
| 6.1 | Controls and displays..... | 6 |
| 6.1.1 | Status display..... | 7 |
| 6.1.2 | Navigation..... | 7 |
| 6.1.3 | Operating structure..... | 7 |
| 6.1.4 | Display symbols..... | 7 |
| 6.2 | Control concept..... | 7 |
| 6.2.1 | Activating/deactivating the function..... | 7 |
| 6.2.2 | Selecting function value..... | 8 |
| 6.2.3 | Activating/deactivating settings..... | 8 |
| 6.2.4 | Selecting the setting value..... | 8 |
| 6.2.5 | Go to the Customer menu..... | 8 |
| 6.3 | Functions..... | 9 |
|  | Turn off appliance..... | 9 |
|  | Connecting to the WLAN..... | 9 |
|  | Temperature..... | 9 |
|  | Temperature unit..... | 10 |
|  | SuperCool..... | 10 |
|  | PowerCool..... | 10 |
|  | PartyMode*..... | 10 |
|  | HolidayMode..... | 10 |
|  | SabbathMode..... | 10 |
|  | E-Saver..... | 11 |
|  | CleaningMode..... | 11 |
|  | Display brightness..... | 11 |
|  | Door alarm..... | 11 |
|  | Entry lock..... | 11 |
|  | Info..... | 11 |
|  | Reminder..... | 12 |

| | | |
|---|---|-----------|
|  | Reset..... | 12 |
| 6.4 | Fault messages..... | 12 |
| 6.4.1 | Warnings..... | 12 |
| 6.4.2 | DemoMode..... | 12 |
| 7 | Features..... | 12 |
| 7.1 | Door rack..... | 12 |
| 7.2 | Shelves..... | 12 |
| 7.3 | Dividing shelf*..... | 13 |
| 7.4 | VarioSafe*..... | 13 |
| 7.5 | Drawers..... | 14 |
| 7.6 | EasyFresh-Safe cover..... | 14 |
| 7.7 | Adjusting the moisture levels..... | 15 |
| 7.8 | Pull-out board with bottle basket*..... | 15 |
| 7.9 | Glass shelves..... | 16 |
| 7.10 | Accessories..... | 16 |
| 8 | Maintenance..... | 16 |
| 8.1 | FreshAir carbon filter..... | 16 |
| 8.2 | Disassembling / assembling pull-out systems..... | 17 |
| 8.3 | Defrosting the appliance..... | 17 |
| 8.4 | Cleaning the appliance..... | 17 |
| 9 | Customer help..... | 18 |
| 9.1 | Technical specifications..... | 18 |
| 9.2 | Operating noises..... | 18 |
| 9.3 | Technical fault..... | 18 |
| 9.4 | Customer Services..... | 19 |
| 9.5 | Model plate..... | 20 |
| 10 | Shutting down..... | 20 |
| 11 | Disposal..... | 20 |
| 11.1 | Preparing appliance for disposal..... | 20 |
| 11.2 | Disposing of the appliance in an environmentally friendly manner..... | 20 |

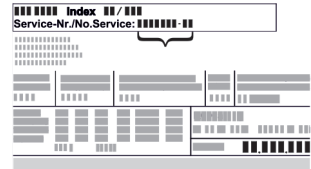
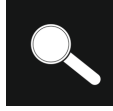
The manufacturer is continually working on the further development of all types and models. Please be aware that we reserve the right to make changes to the shape, equipment and technology.

| Symbol | Explanation |
|---|---|
|  | Read instructions Please read the information in these instructions carefully to understand all of the benefits of your new appliance. |
|  | Full instructions on the internet You can find detailed instructions on the internet using the QR code on the front of these instruction or by entering the service number at home.liebherr.com/fridge-manuals . The service number can be found on the serial tag:  <i>Fig. Example illustration</i> |
|  | Check appliance Check all parts for transport damage. If you have any complaints, please contact your agent or customer service. |

| Symbol | Explanation |
|--|---|
|  | Differences These instructions apply to a range of models, so differences are possible. Sections that apply to certain models only are marked with an asterisk (*). |
|  | Instructions and results Instructions are marked with a ▶. Results are marked with a ▷. |
|  | Videos Videos about the appliances are available on the YouTube channels of Liebherr-Hausgeräte. |

These operating instructions apply to:

| | |
|----------|------------------------|
| R(D) ... | 42../ 46../ 50../ 52.. |
| Kf/ Ksfe | 46../ 52.. |
| SR ... | 52.. |

1 Appliance at a glance

1.1 Scope of delivery

Check all parts for damage during transport. If you have any complaints, please contact your retailer or Customer Services (see 9.4 Customer Services).

Your new appliance comes with the following parts:

- Standalone appliance
- Features (depending on the model)
- Installation materials (depending on the model)
- "Quick Start Guide"
- "Installation Guide"
- Service Brochure

1.2 Overview of the appliance and features

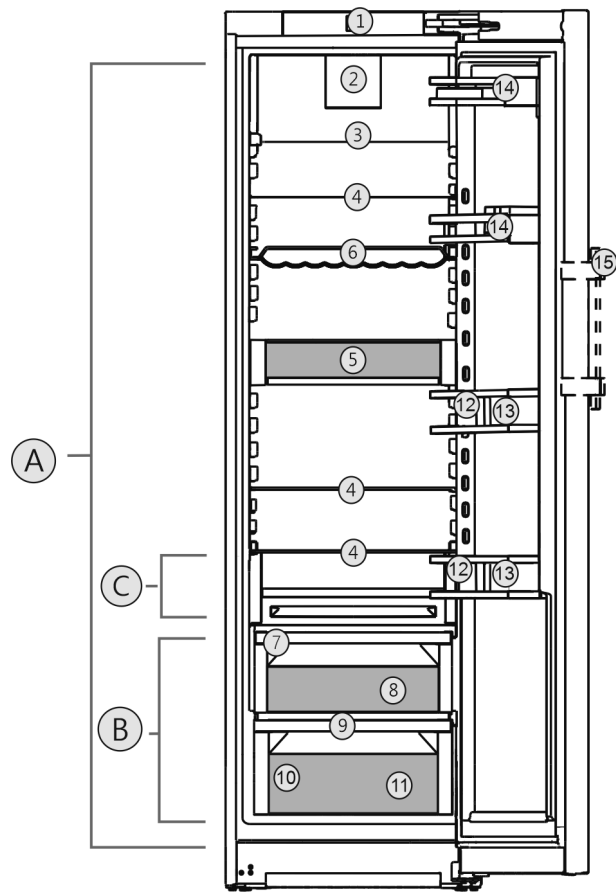

Fig. 1 Example illustration

Temperature range

- (A) Fridge compartment (B) EasyFresh
(C) Coldest zone

Features

- | | |
|---|------------------------|
| (1) Controls | (9) Outlet |
| (2) Fan with FreshAir activated charcoal filter | (10) Serial tag |
| (3) Separable storage shelf* | (11) Vegetable drawer* |
| (4) Storage shelf | (12) Bottle rack* |
| (5) VarioSafe* | (13) Bottle holder |
| (6) Bottle shelf* | (14) Can rack |
| (7) EasyFresh safe cover | (15) Lever handle* |
| (8) EasyFresh safe | |

Note

- ▶ Shelves, drawers and baskets are arranged for optimum energy efficiency when the appliance is delivered. Changing how the shelves, for example, are inserted in the fridge compartment does not have any impact on energy consumption.

1.3 Appliance range of use

Intended use

The appliance is only suitable for cooling food products in a domestic or household-like environment. This includes, for example, use:

- in staff kitchens, bed and breakfast establishments,

General safety instructions

- by guests in country houses, hotels, motels and other accommodation,
- for catering and similar services in the wholesale trade.

The appliance is not suitable for freezing food;

The appliance is not suitable as a built-in unit.

All other types of use are not permitted.

Foreseeable misuse

The following applications are expressly forbidden:

- Storing and refrigerating medicines, blood plasma, laboratory preparations or similar substances and products based on the Medical Device Directive 2007/47/EC
- Use in areas at risk of explosions

Misusing the appliance may lead to damage to the goods stored or they may spoil.

Climate classifications

Depending on the climate classification the appliance is designed to operate in restricted ambient temperatures. The climate classification applying to your appliance is printed on the rating plate.

Note

► Keep to the specified ambient temperatures in order to guarantee that the appliance works properly.

| Climate classification | for ambient temperatures of |
|------------------------|-----------------------------|
| SN | 10 °C to 32 °C |
| N | 16 °C to 32 °C |
| ST | 16 °C to 38 °C |
| T | 16 °C to 43 °C |

1.4 Conformity

The refrigerant circuit has been tested for leaks. The appliance complies with the applicable safety regulations and with the corresponding directives.

The full text of the EU Declaration of Conformity is available on the following website: www.Liebherr.com

1.5 EPREL database

Details about energy labelling and ecodesign requirements will be available on the European product database (EPREL) from 1st March 2021. You can access the product database at the following link: <https://eprel.ec.europa.eu/> You will be asked to enter the model ID. You can find the model ID on the nameplate.

2 General safety instructions

Please keep these operating instructions in a safe place so you can refer back to them at any time.

If you pass the appliance on, please hand these operating instructions to the next user.

Read these operating instructions carefully before use to ensure safe and correct use of the appliance. Follow the instructions, safety instructions and warning messages included at all times. They are important for ensuring you can operate and install the appliance safely and without any problems.

Danger for the user:

- This device can be used by children and people with impaired physical, sensory or mental abilities or with a lack of experience and knowledge provided that they are supervised or have received instruction in the safe use of this device, and about the resulting hazards. Children must not play with this appliance. Cleaning and user maintenance work must not be carried out by children without adult supervision. Children aged between 3 and 8 are allowed to load and unload the appliance. Children below the age of 3 must be kept away from the appliance unless they are under continuous adult supervision.
- The socket must be easily accessible so that the appliance can be disconnected quickly from the electricity in an emergency. It must not be located in the area behind the appliance.
- When disconnecting the appliance from the supply, always take hold of the plug. Do not pull the cable.
- In the event of a fault pull out the mains plug or deactivate the fuse.
- Do not damage the mains power cable. Do not operate the appliance with a defective mains power cable.
- Only customer service or other specially trained staff may repair or perform other operations on the appliance.
- Only assemble, connect and dispose of the appliance according to the instructions.

Fire hazard:

- The coolant used (information on the model plate) is ecofriendly but also flammable. Any leaking coolant may ignite.
 - Do not damage the refrigerant circuit pipes.

- Do not handle ignition sources inside the appliance.
- Do not use electrical appliances inside the appliance (e.g. steam cleaners, heaters, ice cream makers, etc.).
- If the refrigerant leaks: remove any naked flames or ignition sources from the vicinity of the leakage point. Properly air the room. Inform customer services.
- Do not store explosives or sprays using combustible propellants such as butane, propane, pentane, etc. in the appliance. To identify these spray cans, look for the list of contents printed on the can, or a flame symbol. Gases possibly escaping may ignite due to electrical components.
- Keep burning candles, lamps and other items with naked flames away from the appliance so that they do not set the appliance on fire.
- Please be sure to store alcoholic drinks or other packaging containing alcohol in tightly closed containers. Any alcohol that leaks out may be ignited by electrical components.

Danger of tipping and falling:

- Do not misuse the plinth, drawers, doors etc. as a step or for support. This applies particularly to children.

Danger of food poisoning:

- Do not consume food which has been stored too long.

Danger of frostbite, numbness and pain:

- Avoid prolonged skin contact with cold surfaces or refrigerated/frozen goods or take protective measures, e.g wear gloves.

Danger of injury and damage:

- Hot steam can lead to injury. Do not use electrical heating or steam cleaning equipment, open flames or defrosting sprays to defrost.
- Do not use sharp implements to remove the ice.

Risk of crushing:

- Do not hold the hinge when opening and closing the door. Fingers may get caught.

Symbols on the appliance:



This symbol may be located on the compressor. It relates to the oil in the compressor and makes reference to the risk that: Swallowing or inhaling can be fatal. This advice is only relevant to recycling. There is no danger in normal operation.



This symbol is located on the compressor and indicates the danger of flammable materials. Do not remove the sticker.



This or a similar sticker may be located on the rear of the appliance. It refers to the foam-padded panels in the door and/or the housing. This advice is only relevant to recycling. Do not remove the sticker.

Please note the warning messages and other specific advice in the other chapters:

| | | |
|--|---------|---|
| | DANGER | indicates an immediately hazardous situation which will lead to death or serious injuries if it is not avoided. |
| | WARNING | indicates a hazardous situation which may lead to death or serious injuries if it is not avoided. |
| | CAUTION | indicates a hazardous situation which may lead to minor or moderate injuries if it is not avoided. |
| | NOTICE | indicates a hazardous situation which may lead to damage to property if it is not avoided. |
| | Note | indicates useful instructions and tips. |

3 Putting into operation

3.1 Switching on appliance

Ensure that the following conditions are met:

- Appliance is set up and connected according to installation instructions.
- All adhesive strips, adhesive and protective films as well as transport safety devices in and on the appliance are removed.
- All marketing leaflets are removed from the drawers.

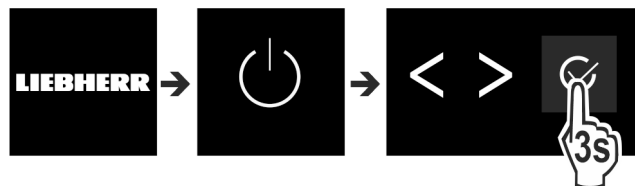

Fig. 2

- ▶ Switch on the appliance using the control panel next to the display.
- ▷ The status display appears.

The appliance starts in DemoMode:

If the appliance starts in DemoMode, you can deactivate DemoMode within the next 5 minutes.

Foods management

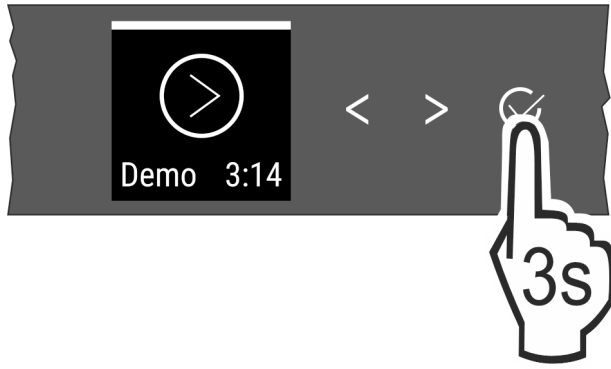

Fig. 3

- ▶ Press Confirm next to the display for 3 seconds.
- ▷ DemoMode is deactivated.

Note

The manufacturer recommends:

- ▶ Place the food inside: Wait for around 6 hours until the set temperature is reached.

3.2 Inserting the components

- ▶ Insert the supplied components to make the most of your appliance.
- ▶ Purchase and install the SmartDevice Box (see smartdevice.liebherr.com).
- ▶ Install the SmartDevice app (see apps.home.liebherr.com).

Note

You can purchase accessories from the Liebherr household appliance store (home.liebherr.com).

4 Foods management

4.1 Storing food



WARNING

Risk of fire

- ▶ Do not use any electrical appliances in the food area of the appliance unless recommended by the manufacturer.

Note

The energy consumption increases and the cooling power goes down if ventilation is not sufficient.

- ▶ Always keep air slots clear.

When storing food, always observe the following:

- Air vents on the inside rear wall are unobstructed.
- Air vents on the fan are unobstructed.
- Food is in sealed packaging.
- Foods that easily absorb or give off smell or taste are stored in sealed containers or covered.
- Raw meat and fish are in clean, sealed containers to prevent them coming into contact with or dripping onto other foods.
- Liquids are in sealed containers.
- Foods are not stored too closely together, as the air needs to circulate.

Note

Failure to follow these guidelines can lead to food perishing.

4.1.1 Fridge section

The natural air circulation creates a range of temperatures.

Arrange your food as follows:

- ▶ In the top section and in the door: butter and cheese, preserves and tubes.
- ▶ In the coldest zone *Fig. 1 (C)*: Perishable foods such as ready-to-eat meals, meat and sausages
- ▶ On the bottom shelf: Raw meat and fish

4.1.2 EasyFresh-Safe

This compartment is great for non-packaged foods, such as fruit and vegetables.

The air moisture in the compartment depends on the moisture content of the items being stored and the number of times the door is opened. You can adjust the air moisture.

Arrange your food as follows:

- ▶ Store your loose fruit and vegetables.
- ▶ Excessive air moisture: Regulate the air humidity (see 7.7 Adjusting the moisture levels).

4.2 Storage times

Refer to the specified storage times as a guide.

In the case of foods with a minimum shelf life, the date indicated on the packaging still applies.

4.2.1 Fridge section

Always follow the best-before date stated on the packaging.

5 Saving energy

- Pay attention to good ventilation. Do not cover ventilation holes or grids.
- Always keep the fan air slits clear.
- Do not install the appliance in direct sunlight, next to an oven, radiator or similar.
- Energy consumption depends on the installation conditions, e.g. the ambient temperature (see 1.3 Appliance range of use). A warmer ambient temperature can increase the energy consumption.
- Open the appliance for as short a time as possible.
- The lower the temperature is set the higher the energy consumption.
- Sort your food: home.liebherr.com/food.
- Keep all food properly packed and covered. This prevents frost from forming.
- Only take food out for as long as necessary so that it doesn't warm up too much.
- Inserting warm food: allow to cool down to room temperature first.
- For longer periods of absence, use HolidayMode (see HolidayMode).

6 Controls

6.1 Controls and displays

The display provides a quick overview of the temperature setting and the status of functions and settings. You can control the functions and settings either by deactivating/activating them or by selecting a value.

6.1.1 Status display

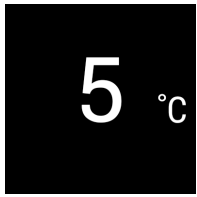

Fig. 4

- (1) Temperature display of the fridge section

The Status display shows the set temperature and is the home display. From there, you can navigate to the options and settings.

6.1.2 Navigation

Navigate in the menu to access the individual functions. An audible signal sounds after confirming a function or setting. If no selection is made after 10 seconds the display switches to the Status display.

The appliance is operated with the buttons next to the display.



Fig. 5

- (1) Navigation arrow left/ right (2) Confirm

Navigation arrow left/right Fig. 5 (1):

- Navigating in the menu. After the last menu page, it goes back to the first one.

Confirm Fig. 5 (2):

- Activating/deactivating a function.
- Open a submenu.
- Confirm a selection. After confirmation the display switches back to the menu.

Back to Status display: in the fastest manner:

- Close and open the door.
- or wait 10 seconds. The display switches to the Status display.

6.1.3 Operating structure

The controls are explained by a template. The display changes depending on the function or settings.

Menu without a submenu

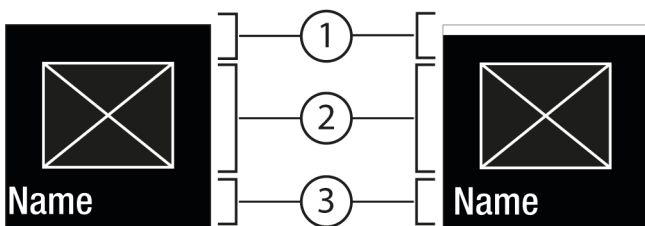

Fig. 6

- (1) Status deactivated / status activated white bar in the top area
 (2) Symbol or activated value
 (3) Menu: Function name or menu: Setting name

Menu with a submenu

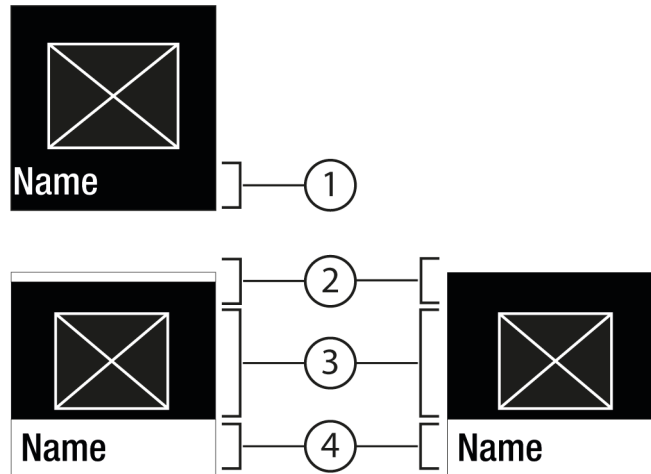

Fig. 7

- (1) Menu: Function name or menu: Setting name
 (2) Status
 (3) Symbol or activated value
 (4) Submenu: function name or submenu: Setting name

(2) off / on

You can navigation as follows:

- Press the left/right Fig. 5 (1) arrow to navigate.
- Press Confirm Fig. 5 (2) to open the submenu Fig. 7 (4).
 - Press the left/right Fig. 5 (1) arrow to navigate.
 - Set a new value: Press Confirm Fig. 5 (2) to select an active value Fig. 6 (1).
 - Back to the menu: Press Confirm Fig. 5 (2) to select the active value Fig. 6 (2).

6.1.4 Display symbols

Display symbols provide information on the current appliance status:

| Symbol | Appliance status |
|--------|---|
| | Standby The appliance or temperature zone is switched off. |
| | Flashing number Appliance is working. Temperature flashes until the set value is reached. |
| | Flashing symbol Appliance is working. Setting is made. |
| | Bar grows steadily Function is activated. |





6.2 Control concept

6.2.1 Activating/deactivating the function

You can activate/deactivate the following functions:

| Symbol | Function |
|--------|------------|
| | SuperCool* |

Controls

| Symbol | Function |
|---|-------------------------|
|  | PowerCool ^x |
|  | PartyMode ^{x*} |
|  | HolidayMode |
|  | E-Saver |

^x When function is on, the appliance works harder. This means appliance noise when operating may be louder for a short while, and more energy will be consumed.

- ▶ Press the navigation arrows *Fig. 5 (1)* repeatedly until the function is displayed.
- ▶ Press Confirm *Fig. 5 (2)*.
- ▷ You hear the confirmation tone.
- ▷ Status appears in the menu.
- ▷ Function is on/off.

6.2.2 Selecting function value

With the following functions you can set a value in the submenu:

| Symbol | Function |
|--|-----------------------------|
|  | Setting the temperature |
| | Switch the appliance on/off |







- ▶ Tap the navigation arrows *Fig. 5 (1)* repeatedly until the function is displayed.
- ▶ Press Confirm *Fig. 5 (2)*.
- ▶ Select the setting value with the navigation arrows *Fig. 5 (1)*.

Setting the temperature

- ▶ Press Confirm *Fig. 5 (2)*.
- ▷ You hear the confirmation tone.
- ▷ Status: On *Fig. 6 (1)* appears briefly in the submenu *Fig. 7 (4)*.
- ▷ Display switches back to the menu.

6.2.3 Activating/deactivating settings

You can activate/deactivate the following settings:

| Symbol | Setting |
|---|----------------------------|
|  | WiFi ¹ |
|  | Entry lock ² |
|  | SabbathMode ² |
|  | Cleaning Mode ² |
|  | Reminders ¹ |
|  | Reset ² |

| Symbol | Setting |
|---|-------------------------|
|  | Switch off ² |

- ▶ Tap the navigation arrows *Fig. 5 (1)* repeatedly until the  settings appear.
- ▶ Press Confirm *Fig. 5 (2)*.
- ▶ Tap the navigation arrows *Fig. 5 (1)* repeatedly until the desired setting is displayed.

¹ Activate setting (shortpress)



- ▶ Press Confirm *Fig. 5 (2)*.
- ▷ You hear the confirmation tone.
- ▷ Status appears in the menu.
- ▷ Setting is on / off.

² Activate setting (longpress)

- ▶ To Confirm *Fig. 5 (2)*, press for 3 seconds.
- ▷ You hear the confirmation tone.
- ▷ Status appears in the menu.
- ▷ Display changes.

6.2.4 Selecting the setting value

With the following settings you can set a value in the submenu:



| Symbol | Settings |
|---|------------|
|  | Brightness |
|  | Door alarm |
|  | Temp. unit |

- ▶ Tap the navigation arrows *Fig. 5 (1)* repeatedly until settings  appears.
- ▶ Press Confirm *Fig. 5 (2)*.
- ▶ Tap the navigation arrows *Fig. 5 (1)* repeatedly until the desired setting is displayed.
- ▶ Press Confirm *Fig. 5 (2)*.
- ▶ Select the setting value with the navigation arrows *Fig. 5 (1)*.
- ▶ Press Confirm *Fig. 5 (2)*.
- ▷ You hear the confirmation tone.
- ▷ Status appears briefly in the submenu.
- ▷ Display switches back to the menu.

6.2.5 Go to the Customer menu

You can see the following settings in the Customer menu:

| Symbol | Function |
|---|----------|
|  | Software |

- ▶ Press the navigation arrows *Fig. 5 (1)* repeatedly until the settings  appear.
- ▶ Press Confirm *Fig. 5 (2)*.
- ▶ Press the navigation arrows *Fig. 5 (1)* repeatedly until the appliance information  appears in the display.
- ▶ Press Confirm *Fig. 5 (2)*.
- ▶ Enter the numerical code 151.
- ▷ The customer menu appears.
- ▶ Press the navigation arrows *Fig. 5 (1)* repeatedly in the customer menu until the desired setting appears.

¹ Select the value

- ▶ Press Confirm *Fig. 5 (2)*.

- ▷ You hear the confirmation tone.
- ▷ Status appears briefly in the display.
- ▷ Display switches back to the menu.

² Activate the setting

- ▶ To Confirm Fig. 5 (2), press for 3 seconds.
- ▷ You hear the confirmation tone.
- ▷ Status appears on the display.
- ▷ The symbol flashes as long as the appliance is working.

6.3 Functions



Turn off appliance

This setting turns off the whole appliance.

Switching off the entire appliance

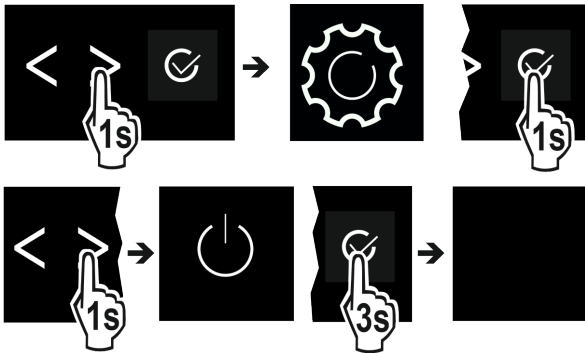

Fig. 8

- ▶ Activating/deactivating (see 6.2 Control concept).
- ▷ Off: Display goes black.



Connecting to the WLAN

This setting connects the appliance to the internet. The connection is managed in the SmartDevice-Box. You can use the SmartDevice-App to add your appliance to a SmartHome-System. Use the SmartDevice-App or other compatible partner networks to enjoy advanced options and settings.

Note

The SmartDevice-Box is available from the [Liebherr Domestic Appliances Shop \(https://home.liebherr.com/shop/de/deu/smartdevicebox.html\)](https://home.liebherr.com/shop/de/deu/smartdevicebox.html).

You can find more information about the availability, prerequisites and the individual options on the Internet under <https://smartdevice.liebherr.com/install>.

Use:

- Manage the appliance with the SmartDevice-App or a compatible partner network.
- Enjoy advanced functions and settings.
- Check the current status of the appliance in the SmartDevice-App.

- The SmartDevice Box is purchased and installed (see <https://smartdevice.liebherr.com/install>).
- The SmartDevice app is installed (see <https://apps.home.liebherr.com/>).

Setting up the connection

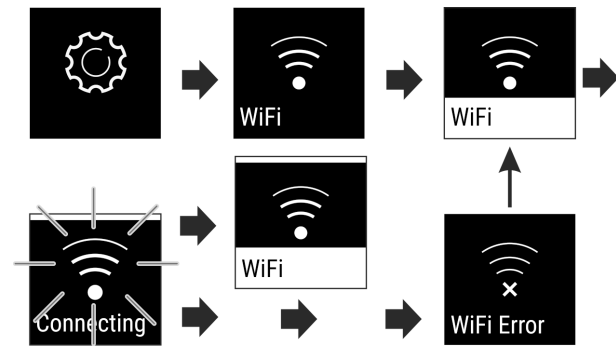

Fig. 9

- ▶ Activating the setting (see 6.2 Control concept).
- ▷ The connection is set up: Status: on Fig. 6 (1) and WiFi connecting appears. The symbol flashes.
- ▷ The connection is set up: Status: on Fig. 6 (1) appears.
- ▷ The connection failed: Status and Connect appears. The symbol appears permanently.

Disconnecting the appliance

- ▶ Deactivate the setting (see 6.2 Control concept).

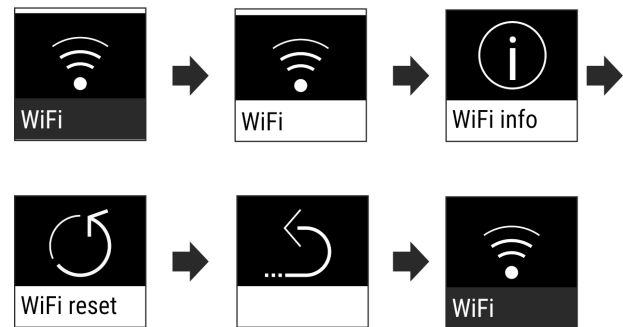

Fig. 10

- ▷ There is no connection: The symbol is displayed constantly.

Restoring the connection

- ▶ Restore settings (see 6.2 Control concept).

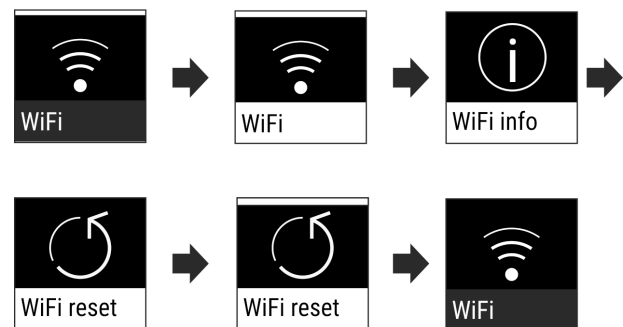

Fig. 11

- ▷ Connection and other settings are restored to factory settings.



Temperature

The temperature depends on the following factors:

- The amount of times the door is opened
- How long the door is open for
- The room temperature of the installation site
- The type, temperature and amount of food

Controls

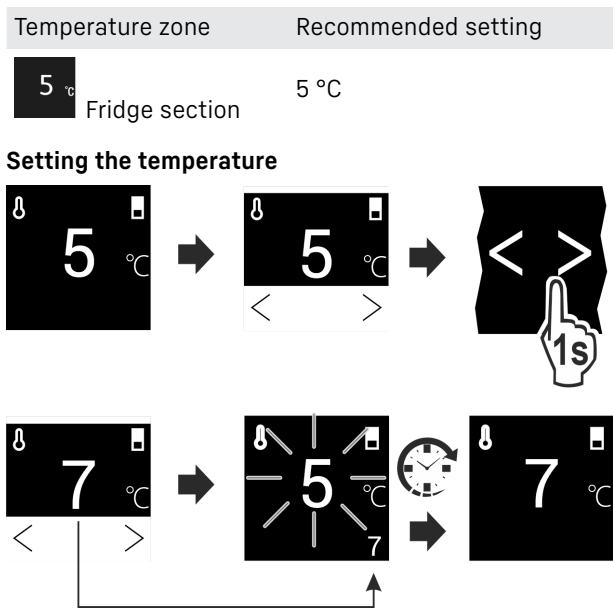

Fig. 12

- ▶ Set the value. (see 6.2 Control concept).
- ▷ Set temperature is shown at the bottom right of the display.

Temperature unit

This setting enables you to switch between Celsius and Fahrenheit as the temperature unit.

Selecting the setting value

- ▶ Set the value (see 6.2 Control concept).

SuperCool

This function selects the lowest cooling temperature. This gives you colder storage temperatures.

This function is relevant to the fridge section Fig. 1 (A)

Use:

- Cool large amounts of food quickly.

Activating/deactivating the function

- ▶ Using the fridge section: activate the function when you add the goods.
- ▶ Activating/deactivating (see 6.2 Control concept).

The function automatically turns off. The appliance goes back to normal mode. The temperature adjusts itself to the set level.

PowerCool

This function provides the perfect blanket temperature to cool your food.

This function refers to the fridge section Fig. 1 (A).

Use:

- At higher room temperatures (from approx. 35 °C)
- When humidity is high e.g. on summer days
- When storing moist goods, to avoid condensation building up inside

Activating/deactivating the function

- ▶ Activating/deactivating (see 6.2 Control concept).

Note

The fan can run even when function is deactivated. This ensures optimal temperature distribution in the appliance.

- ▷ Function activated: Energy consumption of the appliance is slightly increased.

PartyMode*

This option offers an assortment of special functions and settings that are useful if you are having a party.

The following functions are on:

- SuperCool

All the functions can be adjusted flexibly and separately. Changes are discarded when the function turns off.

Activating/deactivating the function

- ▶ Activating/deactivating (see 6.2 Control concept).
 - ▷ On: All functions are activated at the same time.
 - ▷ Deactivated: Previously set temperatures are restored.
- After 24 hours the function turns off automatically.

HolidayMode

This function minimises the energy consumption during an extended absence. The temperature of the refrigerator compartment is set to 15 °C and this is displayed on the status screen when the temperature has been reached.

Use:

- Save energy if you plan to be away for a while.
- Avoid coming home to bad smells and mould.

Activating/deactivating the function

- ▶ Empty everything from the fridge section.
- ▶ Activating/deactivating (see 6.2 Control concept).
- ▷ On: Fridge temperature is raised.
- ▷ Off: the previously set temperature is restored.

SabbathMode

This setting meets the religious requirements on the Sabbath and Jewish festivals. Turn on SabbathMode to switch off certain controls. This means you can use the appliance without anyone changing the settings.

You can find a list of Star-K-certified appliances at www.star-k.org/appliances.

This appliance has certification from the "Institute for Science and Halacha".

WARNING

Danger of food poisoning.

If there is a power cut while the appliance is in SabbathMode, this message is not saved. Once power is restored, the appliance continues in SabbathMode. When this mode is over no message about the power cut is displayed on the temperature display.

If there was a power cut during SabbathMode:

- ▶ Check the food for quality. Do not eat the food if it has thawed.

What the appliance does in SabbathMode:

- The Status display continuously shows SabbathMode.
- The display is locked for all functions apart from deactivating SabbathMode.

- Any functions/settings that are already on, remain active.
- The display stays bright when the door is closed.
- Reminders are disabled. The set time intervals are also paused. This function is disabled in SabbathMode.
- Reminders and warnings are not displayed. There are no acoustic signals, and the display does not show warnings or settings such as temperature alarm or door alarm.
- The internal light is off.
- The defrost cycle only works for the specified time without taking account of fridge use.
- After a power cut the appliance automatically returns to SabbathMode.

Activating/deactivating SabbathMode

- ▶ To activate the function, click the arrows next to the display until you see Settings  in the menu and then confirm. The menu changes to show the available settings.
- ▶ Click the arrows next to the display until you see SabbathMode (Menora) appear. Confirm the symbol.
- ▷ A white bar appears in the top part of the display.
- ▷ SabbathMode is activated.

To deactivate this function, press the button for confirmation next to the display for 3 seconds.

SabbathMode is deactivated.

E-Saver

This function reduces energy consumption. If you activate this function, the cooling temperature increases.

| Temperature zone | Recommended setting (see Temperature) | Temperature when E-Saver activated |
|---|---------------------------------------|------------------------------------|
|  Fridge compartment | 5 °C | 7 °C |

Use:

- Save energy.

Activating/deactivating the function

- ▶ Activating/deactivating (see 6.2 Control concept).
- ▷ Activated: Higher temperatures are set in all temperature zones.
- ▷ Deactivated: Previously set temperatures are restored.

CleaningMode

Use this setting to easily clean the appliance.

This setting refers to the fridge section *Fig. 1 (A)*.

Use:

- Clean the fridge section by hand.

What happens on the appliance when this setting is on:

- The fridge section is switched off.
- The internal light is on.
- Reminders and warnings are not shown. There is no acoustic signal.

Activating/deactivating settings

- ▶ Activating/deactivating the setting (see 6.2 Control concept).
- ▷ On: fridge section is off. Light stays on.
- ▷ Off: preset temperature is restored.

After 60 min the setting turns off automatically. The appliance then continues running in normal mode.



Display brightness

Set the brightness level of the display.

You can set the following brightness levels:

- 40%
- 60%
- 80%
- 100%

Choose the setting

- ▶ Set the level (see 6.2 Control concept).



Door alarm

Set the time before the door alarm (see Close the door) sounds.

The options are as follows:

- 1 min
- 2 min
- 3 min
- Off

Choose the setting

- ▶ Set the time (see 6.4 Fault messages).



Entry lock

This setting prevents unintentional use of the appliance, e.g. by children.

Use:

- Avoid settings being changed unintentionally.
- Avoid the appliance being switched off unintentionally.
- Avoid the temperature being changed unintentionally.

Activating/deactivating settings

- ▶ Activating/deactivating. (see 6.2 Control concept)



Info

This setting allows the appliance information to be read out as well as access to the customer menu.

It provides the following information:

- Model name
- Index
- Serial number
- Service number

Show appliance data

- ▶ Tap the navigation arrows *Fig. 5 (1)* repeatedly until the  settings appear.
- ▶ Press Confirm *Fig. 5 (2)*.
- ▶ Tap the navigation arrows *Fig. 5 (1)* repeatedly until the information is displayed.
- ▶ Read the appliance info.

Features



Reminder

Reminders are given out acoustically by a beep and visually by a symbol in the display. The signal gets louder until the alert stops.



Replace FreshAir active carbon filter

This message appears when the air filter needs replacing.

- ▶ Change the air filter every six months.
- ▶ Confirm the message with OK.
- ▷ The service interval resets.
- ▷ The air filter guarantees the air quality in the fridge.

Activating the setting

- ▶ Activating/deactivating (see 6.2 Control concept) .



Reset

This function resets all settings to the factory settings. All settings that you have made thus far will be reset to their original values.

Activating the setting

- ▶ Activate (see 6.2 Control concept) .

6.4 Fault messages

Fault messages appear in the display. There are two categories of fault message:

| Category | Meaning |
|----------|--|
| Message | Reminder of general procedures. You can carry out these procedures to eliminate the message. |
| Warning | Appears when there are malfunctions. A signal sounds in addition to the display. The signal becomes louder until you acknowledge by tapping the display. You can eliminate simple defects yourself. For more serious defects, you must contact customer service. |

6.4.1 Warnings



Close the door

This message appears if the door is open for too long.

You can set how long it takes for this message to appear .

- ▶ Stop alarm: Confirm the message.

-or-

- ▶ Close the door.



Error

This message appears if there is a fault with the appliance. An appliance component indicates a fault.

- ▶ Open the door.
- ▶ Note down the fault code.
- ▶ Confirm the message.
- ▷ The signal tone stops.
- ▷ The status display appears.
- ▶ Close the door.
- ▶ Contact customer service. (see 9.4 Customer Services)

6.4.2 DemoMode

If "D" appears on the display, demo mode is on. This option is designed for retailers, as it turns off all the cooling functions.

Stopping DemoMode

If you see the following running in the display:

- ▶ Confirm the display within the countdown.
- ▷ DemoMode is off.
- If the timer is not running:
 - ▶ Unplug the appliance.
 - ▶ Plug the appliance in again.
 - ▷ DemoMode is off.

7 Features

7.1 Door rack

7.1.1 Move/remove the door rack

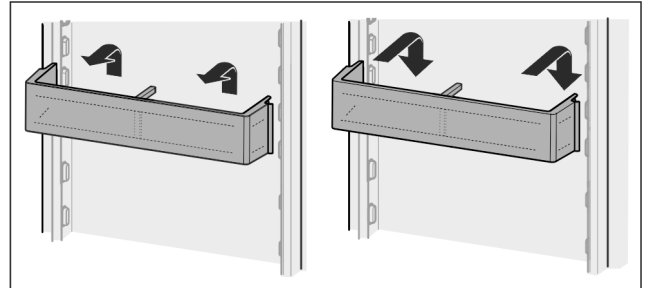

Fig. 13

- ▶ Slide the rack upwards.
- ▶ Pull forwards.
- ▶ Re-insert it in reverse order.

7.1.2 Disassembling the door rack

The door rack can be taken apart for cleaning.

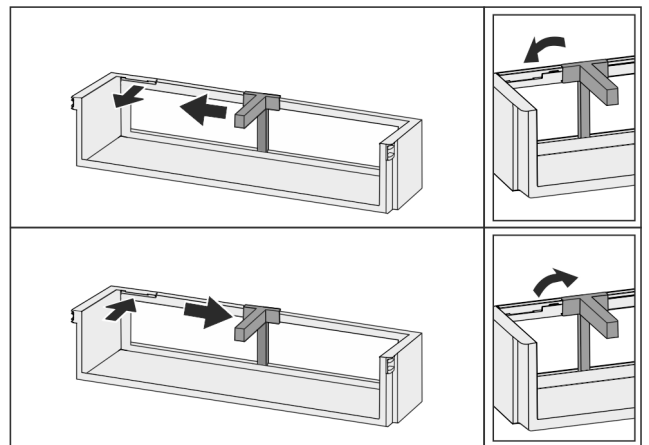

Fig. 14

- ▶ Disassemble the door rack.

7.2 Shelves

7.2.1 Adjusting/removing the shelves

The shelves are prevented from being pulled out accidentally by pull out stops.

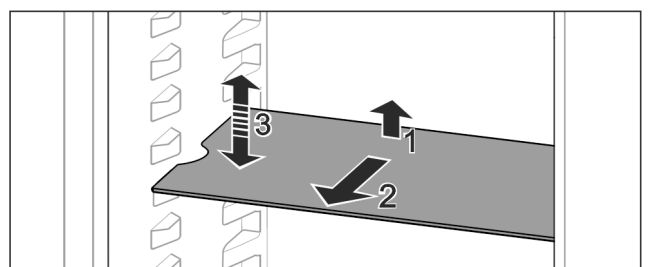

Fig. 15

- ▶ Lift the shelf and pull forward.
- ▷ Line up the side runner.
- ▶ Adjust the height of the shelf: Lift or lower it to the desired height and slide it in.

-or-

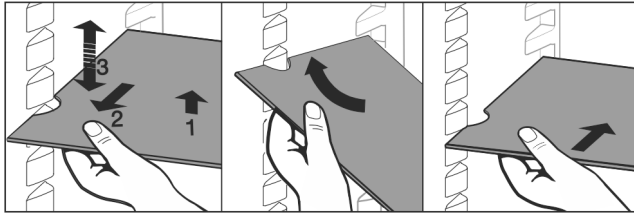

Fig. 16

- ▶ Remove the shelf completely: Pull it out to the front.
 - ▶ Easier removal: Set the shelf at an angle.
 - ▶ Insert the shelf again: Slide it in all the way.
 - ▷ The pull-out stoppers point downwards.
 - ▷ The pull-out stoppers are behind the front support.
- You can also remove the shelf above the EasyFresh compartments.

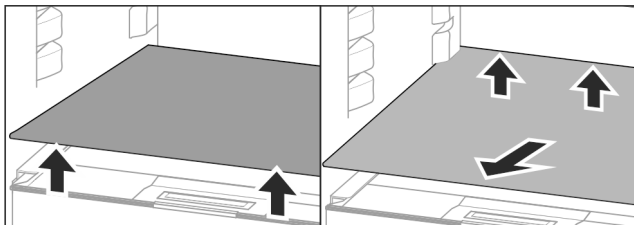

Fig. 17

Removing the shelf:

- ▶ Lift the shelf at the front and back.
- ▶ Pull it out towards you.

Do not store any goods on the compartment cover below!

Inserting the shelf:

- ▶ Place the shelf at an angle, sloping down towards the back.
- ▷ The pull-out stoppers point downwards.
- ▶ Slide the shelf into place.

7.2.2 Dismantling the shelves

The shelves can be dismantled for cleaning.

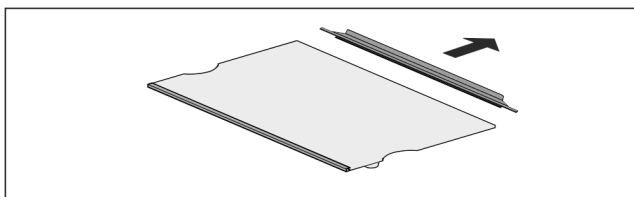

Fig. 18

- ▶ Dismantling the shelf.

7.3 Dividing shelf*

7.3.1 Using the dividing shelf

The shelves are prevented from being pulled out accidentally by pull out stops.

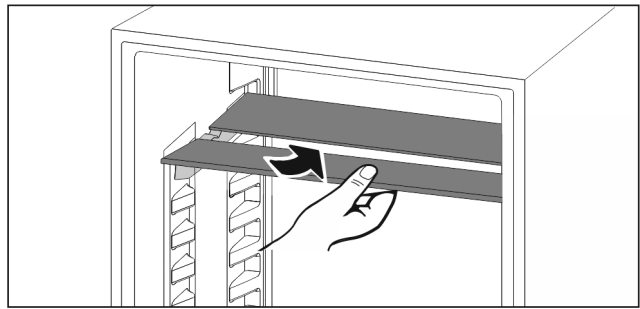

Fig. 19

- ▶ Push the dividing shelf underneath as shown.

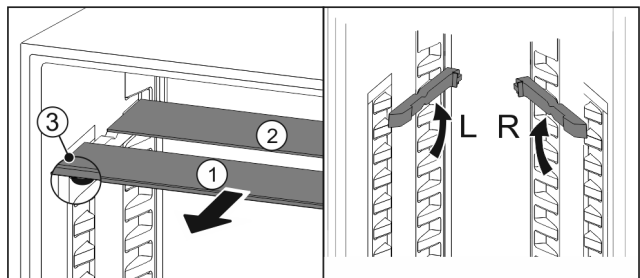

Fig. 20

Adjusting the height:

- ▶ Pull the glass panels out Fig. 20 (1) from the front, one at a time.
- ▶ Release the support rails and click in at the height you want.
- ▶ Slide in the glass panels one at a time.
- ▷ Flat pull-out stoppers at the front, right behind the support rails.
- ▷ High pull-out stoppers at the back.

Using both shelves:

- ▶ Hold the glass panel with one hand and pull it to the front.
- ▷ The glass panel Fig. 20 (1) and trim strip are at the front.
- ▷ The stops Fig. 20 (3) point down.

7.4 VarioSafe*

The VarioSafe provides space for compact foodstuffs and packages, pots and glasses.

7.4.1 Using the VarioSafe

You can remove the drawer and slide it back in at 2 different heights. This is handy for storing taller items in the drawer.

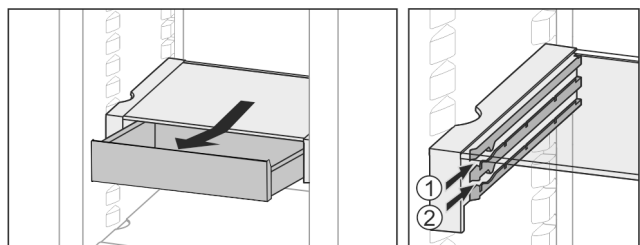

Fig. 21

- ▶ Remove the drawer.
- ▶ Slide back at the height you want Fig. 21 (1) or Fig. 21 (2).

7.4.2 Repositioning the VarioSafe

You can shift the height of the entire VarioSafe.

Features

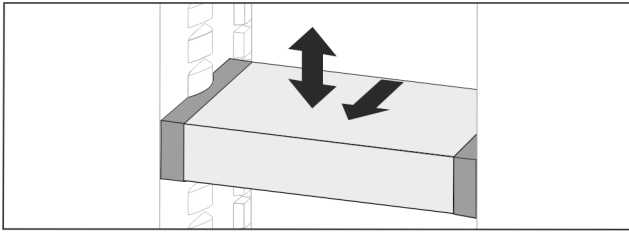

Fig. 22

- ▶ Pull forwards.
- ▷ Line up the side runner.
- ▶ Lift or lower to the height you want.
- ▶ Slide to the rear.

7.4.3 Removing the entire VarioSafe

You can remove VarioSafe as a whole unit.

- ▶ Pull forwards.
- ▷ Line up the side runner.

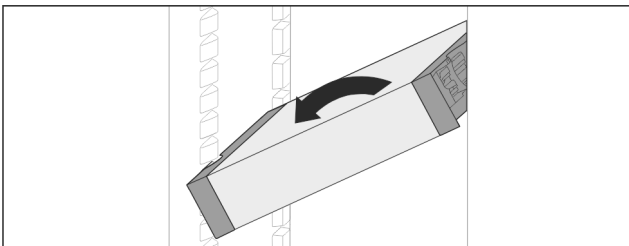

Fig. 23

- ▶ Tip to the side and pull towards you.

7.4.4 Disassembling the VarioSafe

You can take the VarioSafe apart for cleaning.

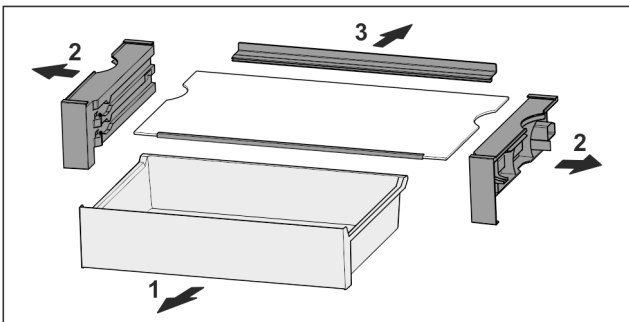

Fig. 24

- ▶ Disassembling the VarioSafe

7.5 Drawers

You can remove the drawers for cleaning.

The way to remove/insert the drawers varies depending on the pull-out system. Your appliance can contain various pull-out systems.

Note

The energy consumption increases and the cooling power goes down if ventilation is not sufficient.

- ▶ Always leave the fan air vents clear on the back wall!

7.5.1 Drawer on rails

Removing drawer

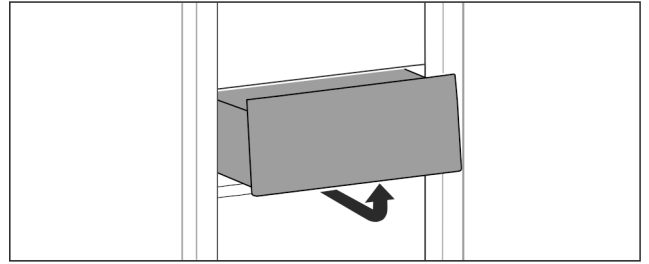

Fig. 25

- ▶ Remove drawer as shown in the illustration.

Inserting drawer

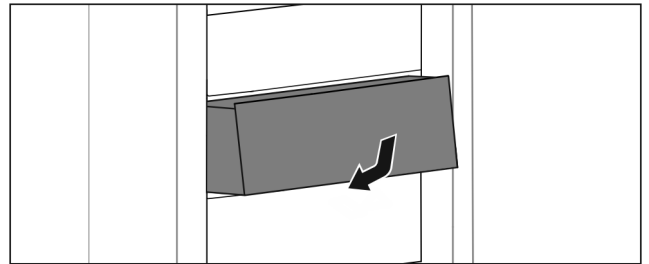

Fig. 26

- ▶ Insert drawer as shown in the illustration.

7.6 EasyFresh-Safe cover

You can remove the compartment cover for cleaning.

7.6.1 Removing the compartment cover

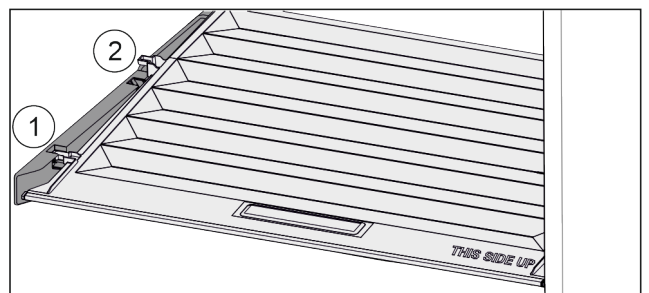

Fig. 27

When the drawers are removed:

- ▶ Pull the lid up at the front to the opening in the retaining parts Fig. 27 (1).
- ▶ Lift from the back and pull it up and out Fig. 27 (2).

7.6.2 Inserting the compartment cover

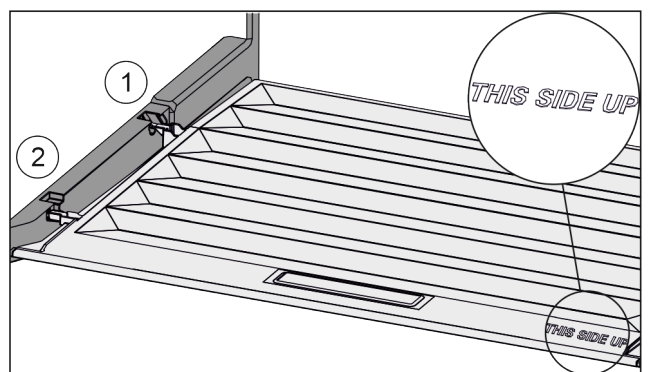

Fig. 28

If the text THIS SIDE UP points upwards:

- ▶ Insert the lip of the cover over the opening of the rear bracket *Fig. 28 (1)* and click into place *Fig. 28 (2)*.
- ▶ Position the cover where you want it (see 7.7 Adjusting the moisture levels).

7.7 Adjusting the moisture levels

You can adjust the moisture in the drawer yourself by adjusting the compartment cover.

The compartment lid is attached to the drawer and can be hidden by a shelf or additional drawers.

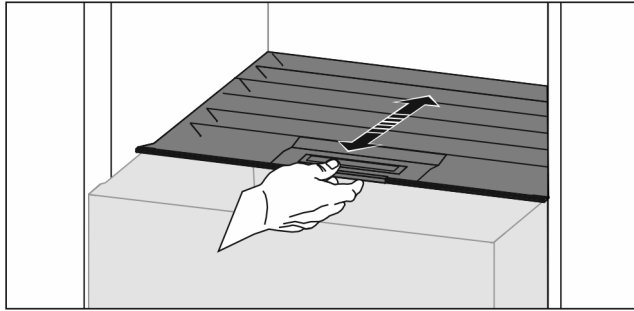

Fig. 29

Low air humidity

- ▶ Open the drawer.
- ▶ Slide the compartment cover forwards.
- ▷ With the drawer closed: Gap between the cover and the compartment.
- ▷ The air moisture in the Safe decreases.

High air moisture

- ▶ Open the drawer.
- ▶ Slide the cover back.
- ▷ With the drawer closed: The cover seals the compartment.
- ▷ The air moisture in the Safe increases.
- If there is too much moisture in the compartment:
- ▶ Choose the setting "low air moisture".

-or-

- ▶ Remove any excess moisture with a cloth.

7.8 Pull-out board with bottle basket*

Removable bottle baskets on the pull-out board offer plenty of space to store bottles. You can remove the bottle baskets to make room for a drinks crate in the pull-out board.

7.8.1 Using the bottle basket

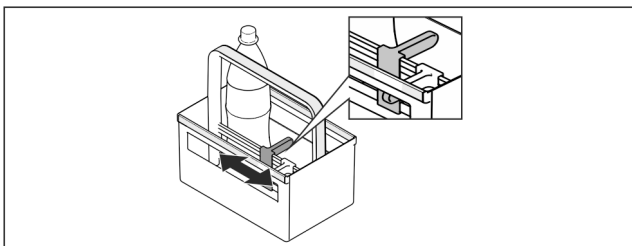

Fig. 30

- ▶ Slide the bottle rack at the edges.
- ▷ The bottles are prevented from falling over.

7.8.2 Disassembling the pull-out board

The pull-out board is mounted on a glass panel with pull-out rails.

You can dismantle the pull-out board for cleaning.

Removing the pull-out board

- ▶ Remove the bottle baskets.

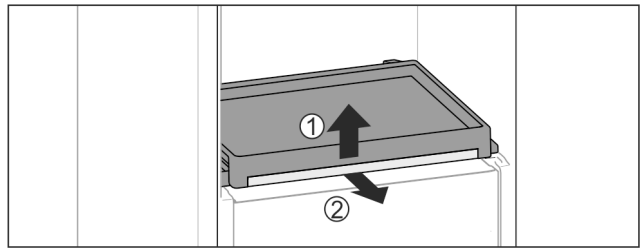

Fig. 31

- ▶ To remove the pull-out board with glass panel: Gently lift the glass panel at the front *Fig. 31 (1)* and pull out to the front *Fig. 31 (2)*.

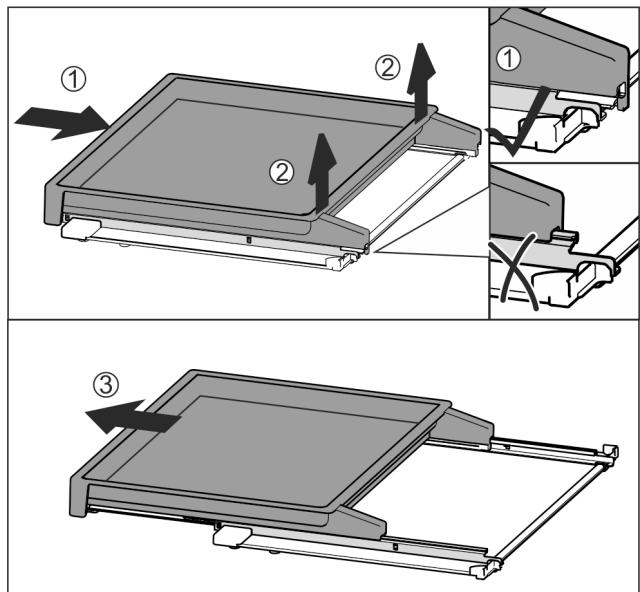

Fig. 32

- ▶ Slide the pull-out board all the way in *Fig. 32 (1)*.
- ▶ Release the clips at the back *Fig. 32 (2)*.
- ▶ Remove the pull-out board from the front *Fig. 32 (3)*.

Inserting the pull-out board

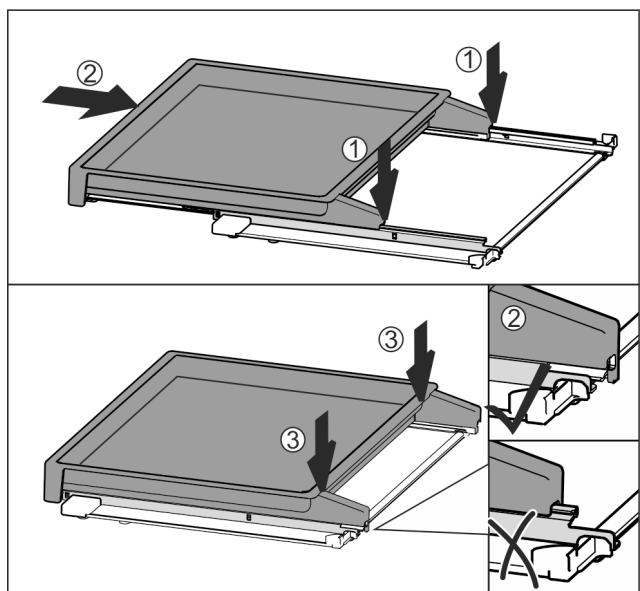

Fig. 33

- ▶ Place centrally on the rails *Fig. 33 (1)*.
- ▶ Slide the pull-out board all the way in *Fig. 33 (2)*.
- ▶ Press down at the back until it clicks into place *Fig. 33 (3)*.
- ▶ To insert the pull-out board with glass panel: Slide to the rear.

Maintenance

7.9 Glass shelves

You can remove the glass shelves under the drawers for cleaning.

7.9.1 Removing / inserting the glass shelf

Make sure that the following requirements are fulfilled:

- ❑ Glass shelf under the drawer: The drawer has been removed. (see 7.5 Drawers)
- ❑ Pull-out board under the bottle basket: Bottle basket has been removed. (see 7.8 Pull-out board with bottle basket*) *

Removing glass shelf

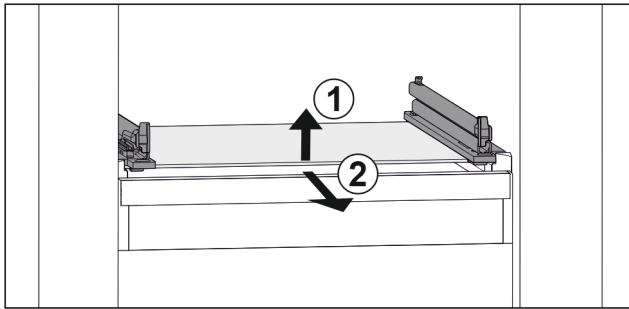

Fig. 34 Example illustration of glass shelf

- ▶ Lift glass shelf at the front. Fig. 34 (1)
- ▶ Take out glass shelf to the front. Fig. 34 (2)

Inserting glass shelf

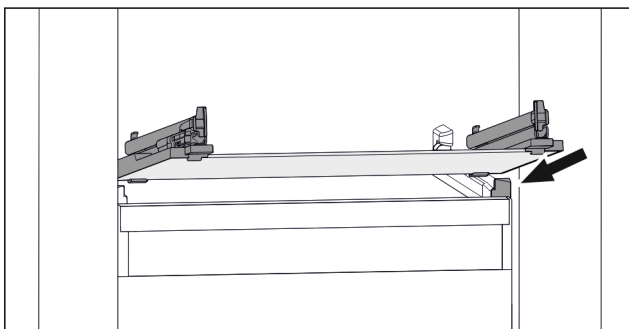

Fig. 35 Example illustration of glass shelf

- ▶ Position glass shelf at an angle behind the stoppers. (see Fig. 917)
- ▶ Lower glass shelf.
- ▶ Slide in glass shelf to the back.

7.10 Accessories

7.10.1 Bottle holder

Using the bottle holder

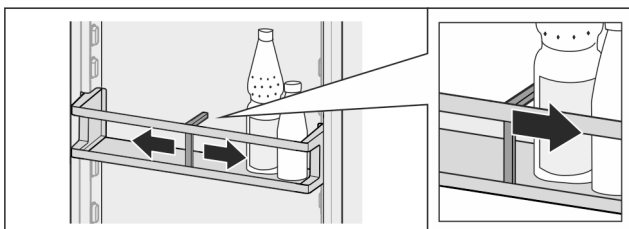

Fig. 36

- ▶ Push the bottle holder onto the bottles.
- ▷ The bottles are prevented from falling over.

Removing the bottle holder

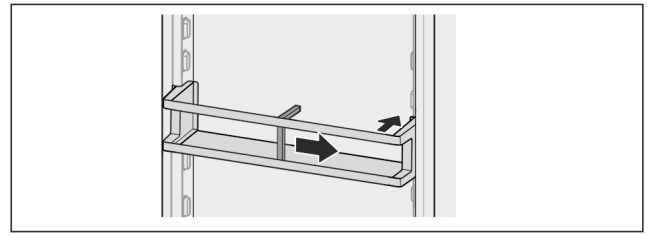

Fig. 37

- ▶ Move the bottle holder all the way to the right.
- ▶ Push the bottle holder to the back to remove.

8 Maintenance

8.1 FreshAir carbon filter

The FreshAir carbon filter is in the compartment above the fan.

It guarantees the best air quality.

- ❑ Replace the carbon filter every 6 months.
With the *Reminder* setting on, a message on the display prompts you to replace it.
- ❑ The carbon filter can be disposed of with the regular household waste.

Note

You can purchase the FreshAir carbon filter from the [Liebherr household appliance store](http://home.liebherr.com) (home.liebherr.com).

8.1.1 Removing the FreshAir carbon filter

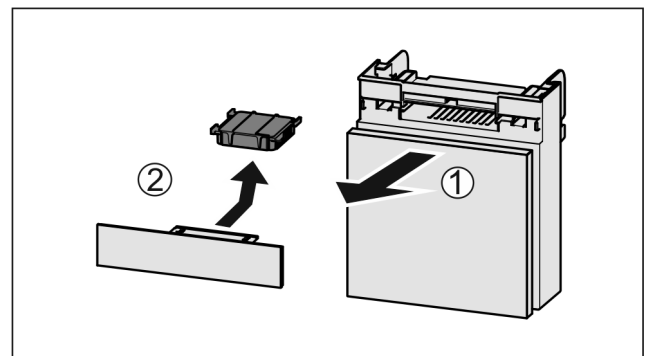

Fig. 38

- ▶ Pull out the compartment Fig. 38 (1).
- ▶ Remove the carbon filter Fig. 38 (2).

8.1.2 Inserting the FreshAir carbon filter

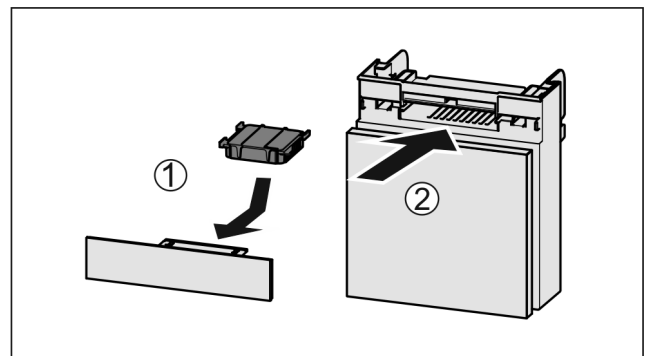

Fig. 39

- ▶ Insert the carbon filter as shown in the diagram Fig. 39 (1).
- ▷ The carbon filter clicks into place.

If the carbon filter is pointing downwards:

- ▶ Push the compartment in *Fig. 39 (2)*.
- ▷ The carbon filter is now ready for use.

8.2 Disassembling / assembling pull-out systems

8.2.1 Notes on disassembly

You can disassemble some of the pull-out systems for cleaning. Your appliance can contain a variety of pull-out systems.

The following pull-out systems can be disassembled or cannot be disassembled:

| Pull-out system | can be disassembled / cannot be disassembled |
|------------------------------------|--|
| Drawer on rails | cannot be disassembled |
| Pull-out board with bottle basket* | can be disassembled (see 8.2.2 Pull-out board with bottle basket*) * |

8.2.2 Pull-out board with bottle basket*

Disassembling pull-out system

Make sure the following prerequisites are met:

- Bottle basket has been removed. (see 7.8 Pull-out board with bottle basket*)
- Glass shelf has been removed. (see 7.9 Glass shelves)

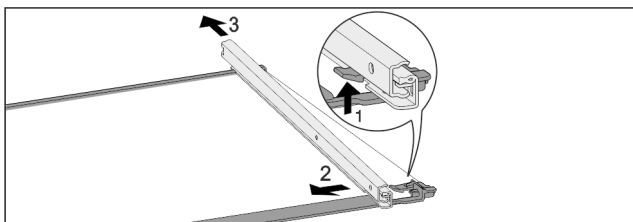

Fig. 40 Glass shelf with rails

- ▶ Push up front click-in hooks. *Fig. 40 (1)*
- ▶ Move the pull-out rails to the side *Fig. 40 (2)* and to the rear *Fig. 40 (3)*.

Installing pull-out system

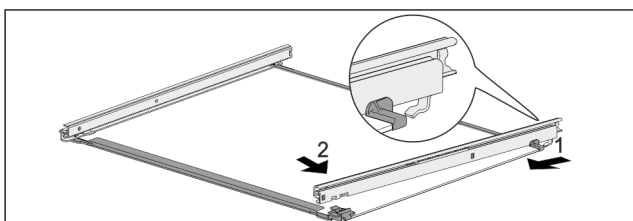

Fig. 41 Glass shelf with rails

- ▶ Hook in rail at the back. *Fig. 41 (1)*
- ▶ Hook in rail at the front. *Fig. 41 (2)*

8.3 Defrosting the appliance



WARNING

Improper defrosting of the appliance!
Injuries and damage.

- ▶ Do not use mechanical equipment or other methods to speed up the defrosting process other than those recommended by the manufacturer.
- ▶ Do not use electrical heating or steam-cleaning appliances, naked flames or defroster sprays to defrost.
- ▶ Do not use sharp objects to remove ice.

Defrosting is performed automatically. The water from the thawing process drains through the outlet and evaporates.

Water drops or a thin layer of frost or ice can form on the back wall; this is a completely normal part of the appliance's function. This must not be removed.

A layer of frost or ice can form briefly due to the energy-optimised control of the device.

- ▶ Clean the drain opening regularly (see 8.4 Cleaning the appliance).

8.4 Cleaning the appliance

8.4.1 Ready



WARNING

Danger of electric shock!

- ▶ Remove the refrigerator connector or interrupt the power supply.



WARNING

Risk of fire

- ▶ Do not damage the refrigeration circuit.

- ▶ Empty the appliance.
- ▶ Remove mains connector.

-or-

- ▶ Activate CleaningMode. (see CleaningMode)

8.4.2 Clean the housing

NOTICE

Improper cleaning!
Damage to the appliance.

- ▶ Only use soft cleaning cloths and ph-neutral all-purpose cleaners.
- ▶ Do not use abrasive sponges or steel wool which may cause scratches.
- ▶ Do not use any sharp or abrasive cleaning agents, nor any that contain sand, chloride or acid.



WARNING

Risk of injury and damage as a result of hot steam!
Hot steam can lead to burns and can damage the surfaces.

- ▶ Do not use any steam cleaners!

- ▶ Wipe the housing down with soft, clean cloth. If very dirty, use lukewarm water with a neutral cleaner. Glass surfaces can also be cleaned with glass cleaner.

8.4.3 Cleaning the interior

NOTICE

Improper cleaning!
Damage to the appliance.

- ▶ Only use soft cleaning cloths and ph-neutral all-purpose cleaners.
- ▶ Do not use abrasive sponges or steel wool which may cause scratches.
- ▶ Do not use any sharp or abrasive cleaning agents, nor any that contain sand, chloride or acid.

- ▶ Plastic surfaces: clean by hand with a soft clean cloth, lukewarm water and a little detergent.
- ▶ Metal surfaces: clean by hand with a soft clean cloth, lukewarm water and a little detergent.
- ▶ Drain outlet *Fig. 1 (9)*: remove any deposits with a thin item such as a cotton bud.

Customer help

8.4.4 Clean the components

NOTICE

Improper cleaning!

Damage to the appliance.

- ▶ Only use soft cleaning cloths and ph-neutral all-purpose cleaners.
- ▶ Do not use abrasive sponges or steel wool which may cause scratches.
- ▶ Do not use any sharp or abrasive cleaning agents, nor any that contain sand, chloride or acid.

Clean with a soft, clean cloth, lukewarm water and some detergent:

- Door rack
- Shelf
- Dividing shelf*
- VarioSafe*
- Bottle basket and pull-out panel*
- EasyFresh-Safe cover
- Drawer

Wash in the dishwasher up to 60 °C:

- Bottle rack
- Holder of the dividing shelf*
- ▶ To disassemble components: see the relevant section.
- ▶ Clean the components.

8.4.5 After cleaning

- ▶ Wipe the appliance and the components dry.
- ▶ Connect and switch on the appliance. The temperature is cold enough:
- ▶ Place the food inside.
- ▶ Repeat cleaning regularly.

9 Customer help

9.1 Technical specifications

| Temperature range | |
|-------------------|--------------|
| Cooling | 2 °C to 9 °C |

| Maximum component capacity | | | |
|----------------------------|--|--|--|
| Features | Appliance width 550 mm (see installation instructions, appliance dimensions) | Appliance width 600 mm (see installation instructions, appliance dimensions) | Appliance width 700 mm (see installation instructions, appliance dimensions) |
| Pull-out board* | 20 kg* | 20 kg* | 20 kg* |

| Lighting | |
|--|--------------|
| Class ¹ | Light source |
| This product contains a light source that meets energy efficiency rating G | LED |

¹ The appliance may contain light sources with different energy efficiency classes. The lowest energy efficiency class is indicated.

9.2 Operating noises

The appliance makes different noises when it is on.

- At **higher temperatures** the appliance uses less energy but works for longer. It is **quieter**.
- At **lower temperatures** the food is cooled faster. It is **louder**.

Examples:

- Functions on (see 6.3 Functions)
- Fan running
- Food recently added
- High ambient temperature
- Door open for a while

| Noise | Possible cause | Type of noise |
|------------------------|---|------------------------|
| Bubbling and splashing | Coolant flowing into the cooling circuit. | Normal operating noise |
| Hissing | Coolant sprays into the cooling circuit. | Normal operating noise |
| Humming | The appliance is cooling. The volume depends on the cooling output. | Normal operating noise |
| Suction noises | Soft-closing door is being opened and closed. | Normal operating noise |
| Humming and rustling | The fan is running. | Normal operating noise |
| Clicking | Components are switched on and off. | Normal switching noise |
| Rattling humming or | Valves or flaps are working. | Normal switching noise |
| Faint knocking | The valve is active. | Normal operating noise |
| Humming or buzzing | The valve is active. | Normal operating noise |

| Noise | Possible cause | Type of noise | Lifting |
|-----------|--|-----------------|--|
| Vibration | Improper setup | Defective noise | Level the appliance using the adjustable feet. |
| Rattling | Components, items inside the appliance | Defective noise | Secure components. Leave enough space between the items. |

9.3 Technical fault

Your appliance is designed and built to ensure it works reliably and has a long service life. In the unlikely event that a fault occurs during operation, please check whether it is due to an operating error. If so, you will be charged for the callout and repair costs even if it falls within the warranty period.

You can fix the following faults yourself.

9.3.1 Appliance function

| Defect | Cause | Remedy |
|---|---|--|
| The appliance is not working. | → The appliance is not switched on. | ▶ Switch the appliance on. |
| | → The power plug is not properly plugged into the socket. | ▶ Check the power plug. |
| | → There is something wrong with the power outlet fuse. | ▶ Check the fuse. |
| | → Power cut | ▶ Keep the appliance closed. ▶ Protecting food: Lay freezer packs on top of the food or use another freezer if the power is off for a prolonged period. ▶ Do not re-freeze defrosted food, |
| | → The appliance plug does not fit the appliance properly. | ▶ Check the appliance plug. |
| Temperature is not cold enough. | → The appliance door is not closed properly. | ▶ Close the appliance door. |
| | → Not enough ventilation. | ▶ Keep ventilation grille clear, and clean it. |
| | → The ambient temperature is too high. | ▶ Solution: (see 1.3 Appliance range of use) . |
| | → The appliance was opened too many times or for too long. | ▶ Wait to see if the required temperature corrects itself. If not, contact Customer Service (see 9.4 Customer Services) . |
| | → The temperature is set incorrectly. | ▶ Turn down the temperature and check after 24 hours. |
| | → The appliance is too close to a heat source (oven, radiator, etc). | ▶ Move the appliance or the heat source. |
| The door seal is defective or needs to be replaced for another reason. | → The door seal can be replaced. It can be replaced without the need for special tools. | ▶ Contact Customer Services (see 9.4 Customer Services) . |
| The appliance builds up too much ice or condensation. | → The door seal may have slipped out of its groove. | ▶ Check that the door seal is well fitted in the groove. |
| The appliance is hot to touch on the outside*. | → The heat of the refrigeration circuit is used to avoid condensation. | ▶ This is normal. |

9.3.2 Features

| Defect | Cause | Remedy |
|---|---|---|
| The internal light does not come on. | → The appliance is not switched on. | ▶ Switch the appliance on. |
| | → The door was open for longer than 15 minutes. | ▶ Interior lighting turns off automatically after approx. 15 min. with the door open. |
| | → The LED interior light is faulty or the lid is damaged. | ▶ Contact customer service (see 9.4 Customer Services) . |

9.4 Customer Services

First check if you can fix the error yourself (see 9 Customer help) . If you can't, contact Customer Services.

Please refer to the enclosed "Liebherr-Service" brochure for the address.

Shutting down



WARNING

Unprofessional repair!
Injuries.

- ▶ Have any repairs and action - not expressly specified - on the appliance and mains cable carried out by service personnel only. (see 8 Maintenance)
- ▶ A damaged mains cable may only be replaced by the manufacturer, the manufacturer's Customer Service or a similarly qualified person.
- ▶ In the case of appliances with an IEC connector, the change may be made by the customer.

9.4.1 Contact Customer Services

Make sure you have the following appliance data at the ready:

- Appliance name (model and index)
- Service no. (Service)
- Serial no. (S no.)

- ▶ Look up the appliance information on the display (see Info).

-or-

- ▶ Referring to appliance info on the nameplate (see 9.5 Model plate).
- ▶ Note down the appliance information.
- ▶ Notify Customer Services of the following: Give us the appliance data.
- ▷ This will help us to provide you with a faster, more accurate service.
- ▶ Follow any further instructions given by Customer Services.

9.5 Model plate

The model plate is behind the drawers on the inside of the appliance.

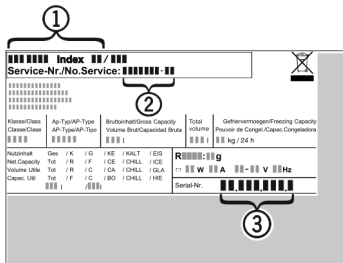

Fig. 42

- (1) Appliance description
 - (2) Service no.
 - (3) Serial no.
- ▶ Note the data on the model plate.

10 Shutting down

- ▶ Empty the appliance.
- ▶ Turn off the appliance.
- ▶ Remove mains connector.
- ▶ Remove appliance connector if required: Remove and move from left to right at the same time.
- ▶ Clean the appliance (see 8.4 Cleaning the appliance).
- ▶ Leave the door open to avoid bad smells building up.

11 Disposal

11.1 Preparing appliance for disposal



Li-Ion

Liebherr uses batteries in some of its appliances. In the EU, for environmental reasons, legislation obliges the end user to remove these batteries before disposing of old appliances. If your appliance contains batteries, a corresponding notice is attached.

Lamps

If you can remove the lamps yourself without destroying them, also remove these before disposal.

- ▶ Take the appliance out of operation.
- ▶ Appliances with batteries: remove the batteries. For description, see **Maintenance** chapter.
- ▶ If possible: remove lamps without destroying them.

11.2 Disposing of the appliance in an environmentally friendly manner



The appliance still contains valuable materials and must be disposed of separately from unsorted municipal waste.



Li-Ion



Li-Ion

Dispose of batteries separately from the old appliance. To do this, you can return the batteries free of charge to retailers as well as recycling centres and collection centres for recyclable materials.

Lamps

Dispose of removed lamps via the respective collection systems.

For Germany:

You can dispose of the appliance free of charge via the class 1 collection containers at the local recycling and recyclable material collection centres. When purchasing a new fridge/freezer, if the sales area > 400 m², retailers will also take back the old appliance free of charge.



WARNING

Leaking coolant and oil!
Fire. The coolant contained in the appliance is eco-friendly, but also flammable. The oil contained in the appliance is flammable. Escaping coolant and oil can ignite if the concentration is high enough and in contact with an external heat source.

- ▶ Do not damage the pipelines of the coolant circuit and the compressor.

- ▶ Transport the appliance without damaging it.
- ▶ Dispose of batteries, lamps and the appliance according to the above specifications.



home.liebherr.com/fridge-manuals

EN fridge

Issue date: 20221206

Part number index: 7080430-02

Liebherr-Hausgeräte Marica EOOD
Bezirk Plovdiv
4202 Radinovo
Bulgarien