

Users Guide & Installation Handbook



Stoves

Freestanding Dual Fuel Wok UK

Part No 083286601 Date 01/08/2013

CONTENTS & INTRODUCTION

CONTENTS

- SAFETY
- USING THE PRODUCT
- CLEANING
- INSTALLATION INSTRUCTIONS
- TECHNICAL DATA
- CUSTOMER CARE

INTRODUCTION

Thank you for buying this British-built appliance from us.

This guide book is designed to help you through each step of owning your new cooker, from installation to use. Please read it carefully before you start using your product, as we have endeavored to answer as many questions as possible, and provide you with as much support as we can.

If, however, you should find something missing, or not covered, please contact our Customer Care team. Their number is located on the back page of this book.

For customers outside the UK and Northern Ireland, please contact your local supplier.

When you dial this number you will hear a recorded message and be given a number of options. This indicates that your call has been accepted and is being held in a queue. Calls are answered in strict rotation as our Customer Care representatives become available.

Alternatively, general information, spares and service information is available from our website. The address is located on the back page of this book.

WARRANTY

Your new appliance comes with our 12-month guarantee, protecting you against electrical and mechanical breakdown. To register your appliance please call **0844 481 0182**, complete the registration form included or register online at the web address located on the back page of this book.

For full terms & conditions of the manufacturer's guarantee, refer to the website on the back of this book.

In addition, you may wish to purchase an extended warranty. A leaflet explaining how to do this is included with your appliance.

Our policy is one of constant development and improvement, therefore we cannot guarantee the strict accuracy of all of our illustrations and specifications - changes may have been made subsequent to publishing.

GAS WARNING

If you smell gas:

Do not try to light any appliance.

Do not touch any electrical switch.

**Call the Gas Emergency Helpline at
TRANSCO on: 0800 111999**

SAFETY

BEFORE USING THE PRODUCT

Make sure that you have removed all packaging and wrapping. Some of the items inside this appliance may have additional wrapping.

It is advised that you turn the ovens and/or grill on for a short while. This will burn off any residues left from manufacturing. There may be a smell which accompanies this process - but this is nothing to worry about and is harmless.

It is recommended that you wash the oven shelves, baking tray, grill pan and grill pan trivet before their first use in hot soapy water. This will remove the protective oil coating.

GENERAL

WARNING! - The appliance and its accessible parts become hot during use. Care should be taken to avoid touching heating elements. Children less than 8 years of age shall be kept away unless continuously supervised. This appliance can be used by children aged from 8 years and above and persons with reduced physical sensory or mental capabilities or lack of experience and knowledge if they have

been given supervision or instruction concerning the use of the appliance in a safe way and understand the hazards involved. Children shall not play with the appliance. Cleaning and user maintenance shall not be made by children without supervision.

WARNING! -

Unattended cooking on a hob with fat or oil can be dangerous and may result in fire.

NEVER try to extinguish a fire with water, but switch off the appliance and then cover the flame with a lid or damp cloth.

WARNING! - Danger of fire: Do not store items on the cooking surfaces.

WARNING! - Servicing should be carried out only by authorised personnel.

SAFETY

WARNING! - The appliance must never be disconnected from the mains supply during use, as this will seriously affect the safety and performance, particularly in relation to surface temperatures becoming hot and gas operated parts not working efficiently. The cooling fan (if fitted) is designed to run on after the control knob has been switched off.

WARNING! -

Do not spray aerosols in the vicinity of this appliance while it is in operation.

WARNING! - Do not store or use flammable liquids or items in the vicinity of this appliance.

WARNING! -

Do not modify this appliance.

WARNING! - Do not use harsh abrasive cleaners or sharp metal scrapers to clean the oven door glass since they can scratch the surface, which may result in shattering of the glass.

WARNING! - Do not operate the appliance without the glass panel correctly fitted.

WARNING! - There is a risk of electric shock, so always make sure you have turned off and unplugged your appliance before starting. Always allow the product to cool down before you change a bulb.

WARNING! - Accessible parts may become hot when the grill is in use. children should be kept

SAFETY

away.

WARNING! - Never place food, or dishes on the base of the main oven, the element is here and it will cause over heating.

WARNING! - Do not modify the outer panels of this appliance in any way.

WARNING! - This appliance must be earthed.

WARNING! - The top element gets extremely hot when in use, so take care to avoid touching it.

WARNING! - The use of inappropriate hob guards can cause accidents.

GAS WARNING! -

If you smell gas:
Do not try to light any appliance.

Do not touch any electrical switch.

Contact your local gas supplier immediately.

Caution: This appliance is for cooking purposes only. It must not be used for other purposes, for example room heating.

OVEN / GRILL

Do

- Always take care when removing food from the oven as the area around the cavity may be hot.
- Always use oven gloves when handling any utensils that have been in the oven as they will be hot.
- Always make sure that the oven shelves are resting in the correct position between two runners. Do not place the oven shelves on top of the highest runner, as this is not stable and can lead to spillage or injury.
- Always use the Minute Minder (if fitted) if you are leaving the oven unattended - this reduces the risk of food burning.

Do Not

- Never place items on the door while it is open.
- Never wrap foil around the oven shelves or allow foil to block the flue.
- Never drape tea towels near the oven while it is on; this will cause a fire hazard.

Never pull heavy items, such as turkeys or large joints of meat, out from the oven on the shelf, as they may overbalance and fall.

SAFETY

- Never use this appliance to heat anything other than food items and do not use it for heating the room.

GAS HOB

Do

- Always ensure that pan bases are dry and flat before using them on the hob.
- Always position pans over the centre of the heat zone, and turn the handles to a safe position so they cannot be knocked or grabbed.
- Always use pans which are no smaller than 100mm (4"), or larger than 250mm (10"). Use a 230 mm (9") pan above the wok burner, if two or more other hotplate burners are in use at the same time.
- Always match the size of pan to the heat zone – do not use large pans on small zones or vice versa.
- Always make sure that the burner caps, rings and pansupports are correctly placed. This will prevent pans becoming unstable while in use and ensure an uninterrupted gas flow.

Do Not

- Never use double pans, rim-based pans, old or misshapen pans, or any pan that is not stable on a flat surface.
- Never leave cooking fat, or oil, unattended.
- Never use commercial simmering aids, or heat diffusers, as they create excessive heat and can damage the surface of the hob.
- Never use the hob for any other purpose than cooking food.
- Plastic cooking utensils can melt if they come into contact with a warm hob. Never leave them close to, or on top of the hob.

- Never leave any heat zone alight without a pan covering it. This causes a fire hazard.
- Never leave an empty pan on a heating zone.
- Never leave anything lying on the hob.
- Never heat a sealed tin of food, as it might explode.
- Never use the hob surface for storage.

Fire Safety Advice

Most kitchen fires occur when people are distracted or leave things unattended. Don't let yourself be distracted while cooking. If you're called away from the cooker, either take pans off the heat, or switch off your hob.

If you do have a fire in the kitchen, don't take any risks - get everyone out of your home and call the Fire Brigade.

If a pan catches fire:

- Do not move it - it is likely to be extremely hot.
- Turn off the heat if it's safe to do so - but never lean over a pan to reach the controls.
- If you have a fire blanket, put it over the pan. If you have put the fire out, leave the pan to cool completely.

Deep-fat frying presents more dangers in your kitchen.

- Never fill a chip pan (or other deep-fat fryer) more than one-third full of oil
- Do not use a fire extinguisher on a pan of oil - the force of the extinguisher can spread the fire and create a fireball.

SAFETY

If you have an electrical fire in the kitchen:

- Pull the plug out, or switch off the power at the fuse box - this may be enough to stop the fire immediately
- Smother the fire with a fire blanket, or use a dry powder or carbon dioxide extinguisher
- Remember: never use water on an electrical or cooking oil fire.

IGNITION PROCEDURE

Prior to ignition:

Hotplate burner(s), position correctly sized, flat bottomed pan(s) directly onto the pan support above the selected burner(s).



Wok burner (if fitted)

a) Position a flat bottomed wok or a correctly sized, flat bottomed pan directly onto the pan support above the wok burner.

b) Position the provided wok stand directly onto the pan support above the wok burner, then position a round bottomed wok directly onto the stand.

Correct procedure for ignition of all gas burners on this appliance.

Manual ignition (if applicable)

- Push in and keep depressed the ignition button . Sparking to all gas burners will commence.
- Push in and turn the selected gas burner control knob to the full flame symbol . Keep the control knob depressed.
- As soon as the selected burner ignites release the ignition button.
- Continue to hold the control knob in for up to 15 seconds then release.
- If the burner fails to ignite within this time, release the control knob and wait 1 minute before attempting to re-ignite.

Automatic ignition (if applicable)

- Push in and turn the selected gas burner control knob to the full flame symbol . Keep the control knob depressed. Sparking to the selected burner will commence automatically. Sparking will cease automatically

once the flame is established.



- Continue to hold the control knob in for up to 15 seconds then release.
- If the burner fails to ignite within this time, release the control knob and wait 1 minute before attempting to re-ignite.

In the event of a power failure, or the ignition not working, then a lighted match or taper can be used to ignite the burner.

USING THE HOB - GAS

- Use pans which are large enough to avoid overflows onto the hob surface.
- Wipe any spillage as soon as possible.
- Clean the hob top as regularly as possible, this will prevent any build up of grease which may be a fire hazard.

Use

- Place your pan onto the pan supports above the burner you wish to use.
- Flat based woks may be positioned onto the pan support directly above the wok burner
- To ignite, see **IGNITION PROCEDURE** page.
- To simmer, turn the control knob to the small flame symbol . This will ensure that the flame is just large enough to gently heat the contents of the pan.
- To turn off, turn the control knob to the off  position.
- Always make sure that your pans are placed centrally on the burners and do not allow the flame to extend over the base of the pan.
- Avoid the use of pans that overhang

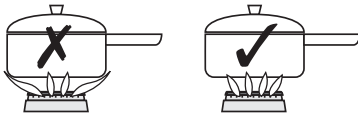

the edges of the hotplate.

- To use a round bottomed wok, position the wok stand provided onto the pan support above the wok burner, then position the wok onto the stand.

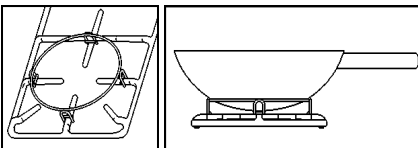

Energy Saving

- Position pans centrally over the burners.
- Only heat the amount of liquid you need.
- Once liquids have been brought to the boil, reduce the heat setting to a simmer.
- Consider using a pressure cooker if possible.
- Vegetables cut into small pieces will cook more quickly.
- Use a pan which is a close match to your burner size.
- Smaller burners are ideal for simmering and stewing in smaller pans, while the larger burners are ideal for frying and boiling.

FOLD DOWN LID (IF FITTED)

Caution: Glass lids may shatter when heated. Turn off all the burners before shutting the lid.

When opening and closing the lid, use the cooler outer sides of the lid glass.

The lid must be opened fully, so there is no danger of it closing while the hob is being used.

The appliance is fitted with a safety system, which will automatically turn off the hotplate burners if they are inadvertently left on as the lid is closed.

The lid is not intended to be used as a work surface, as it becomes hot when any part of the cooker is in use. The surface may be scratched if items with rough or sharp surfaces are placed on it.

Always remove any spillage from lid before opening.

Always allow the hob surface to cool before closing the lid.

Make sure that the wok stand is removed from the pan support before closing lid.

USING THE GRILL - ELECTRIC

Caution: Accessible parts may be hot when the grill is used - young children should be kept away.

A grill pan handle can be purchased as an optional extra from our spares department quoting the part numbers below:

Handle - 082283705

Handle grip - 082469100

Complete grill pan pack - 012635666

Contact details can be found on the customer care page.

If cleaning the grill pan when it is hot, use oven gloves to move it.

Food for grilling should be positioned centrally on the trivet.

Using the grill

Important: The grill door must be fully open when the grill is used.

Open the grill door. Turn the control knob to the required setting. For best cooking results, we recommend that you preheat the dual grill for 3 minutes and the single grill for 5 minutes.

For grilling small quantities of food, the centre (economy) grill can be used with the grill trivet inverted. For large quantities of food, the full grill can be used.

Push the grill pan towards the back of the shelf, to position it under the grill.

The speed of grilling can be controlled by adjusting the grill setting or by selecting a higher or lower shelf position. For toasting, and for grilling foods such as bacon, sausages or steaks, use a higher shelf position. For thicker foods such as chops or chicken joint pieces, use a middle to low shelf position.

The grill trivet, inside the grill pan, can be inverted to give a high or low position, or it may be removed.

To switch off, turn the control knob to the off  position.

Using aluminium foil

Using aluminium foil to cover the grill pan,

Types of grill

Variable rate grill:

has adjustable heat settings 1 (low) to 8 (high) or 5 (high) - depending on the model.

Single grill: has one grill element. The grill pan trivet **MUST** be inverted when using the single grill function.

Dual grill: has two grill elements which can be used together, or as a single grill.

or putting items wrapped in foil under the grill creates a fire hazard.

The cooling fan

When the grill is switched on, the cooling fan comes on to keep the fascia and control knobs cool during grilling. The fan may continue to operate for a period after the grill has been switched off.

During use the fan may cycle on and off, this is normal.

Alternatively, you may have grill symbols similar to these below.

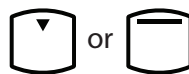

or



Full grill at 1/4 power



Centre grill at full power



Full grill area at full power

USING THE TOP OVEN - ELECTRIC (if fitted)

When you are cooking keep children away from the vicinity of the oven.

Caution: The top element gets extremely hot when in use, so take extra care to avoid touching it.

The top oven is a conventional oven.

Note: The top oven is not controlled by the programmer (if fitted).

To turn on the top oven

Turn the temperature control knob until the required temperature is selected.

The red thermostat indicator will come on until the selected temperature is reached, and then go off; it will turn on and off periodically as the thermostat operates to maintain the selected temperature.

To switch off, return the top oven control knob to the off position.

Important: Never put items directly on the base of the oven, or cover the oven base with foil, as this may cause the element to overheat. Always position items on the shelf.

The cooling fan

When the top oven is switched on, you will hear the cooling fan come on - this keeps the fascia and control knobs of the appliance cool during cooking. The fan may continue to operate for a period after the oven control has been switched off.

Preheating

The oven must be preheated when cooking frozen or chilled foods, and we recommend preheating for yeast mixtures, batters, soufflés, and whisked sponges.

Preheat the oven until the indicator light switches off for the first time, this will take up to 15 minutes depending on the temperature selected.

If you are not preheating the oven, the cooking times in the following guide may need to be extended, as they are based on a preheated oven.

Shelf positions

There are either 3 or 4 shelf positions, depending on which model you have purchased. These are counted from the bottom of the oven upwards, so shelf position 1 is the lowest.

When cooking frozen or chilled food, use the highest possible shelf position, while allowing some clearance between the food and the top element.

The oven shelf must be positioned with the up-stand at the rear of the oven and facing up. Position baking trays and roasting tins on the middle of the shelves, and leave one clear shelf position between shelves, to allow for circulation of heat.

When using the top oven

As part of the cooking process, hot air is expelled through a vent at the top of the oven(s). When opening the oven door, care should be taken to avoid any possible contact with potentially hot air, since this may cause discomfort to people with sensitive skin. We recommend that you hold the underneath of the oven door handle.

USING THE TOP OVEN - ELECTRIC (if fitted)

TOP OVEN BAKING GUIDE

Cooking times

These times are based on cooking in a preheated oven.

These cooking times are approximate, because the size and type of cooking dish will influence time as personal preferences.

Shelf positions

As a general guide, when cooking frozen or chilled food, use the highest possible shelf position, while allowing some clearance between the food and the top element. Follow the instructions given on packaging.

Cooking temperatures

The temperature settings and time given in the Baking Guides are based on dishes made with block margarine. If soft tub margarine is used, it may be necessary to reduce the temperature setting. If a recipe gives a different temperature setting to that shown in the guide, the recipe instruction should be followed.

Because the top oven is more compact, it may be necessary to reduce cooking temperatures specified in recipes by up to 20°C.

Use the baking guide as a reference for determining which temperatures to use.

Item	Temperature (°C)	Shelf Position	Approximate cooking time
Small cakes	180	1	15 - 20 mins
Victoria sandwich (2 x 180mm / 7")	160	1	20 - 25 mins
Swiss roll	200	1	8 - 12 mins
Semi rich fruit cake (180mm x 7")	140	1	2¼ - 2¾ hours
Scones	215	1	10 - 15 mins
Meringues	90 - 100	1	2 - 3 hours
Shortcrust pastry	200 - 210	1	Depends on size & type of cooking dish & also the filling
Puff / flaky pastry	200 - 210	1	
Choux pasrty	200 - 210	1	
Biscuits	160 - 200	2	10 - 20 mins
Sponge pudding	150	1	30 - 45 mins
Milk pudding	140	1	2 - 2½ hours

USING THE MAIN OVEN - ELECTRIC

Accessible parts may be hot when the oven is used. Young children should be kept away.

To switch on the oven

Turn the oven control knob(s) to the required setting.

The red thermostat indicator (if fitted) will come on until the selected temperature is reached and then go off; it will turn on and off periodically as the thermostat operates to maintain the selected temperature.

To switch off, return the control knob to the off ● position.

When using the oven

As part of the cooking process, hot air is expelled through a vent in the oven. When opening the oven door, care should be taken to avoid any possible contact with potentially hot air, since this may cause discomfort to people with sensitive skin. We recommend that you hold the underneath of the oven door handle.

PREHEATING

Fanned oven

When cooking sensitive items such as soufflé and Yorkshire puddings or, when cooking bread, we recommend that the oven is preheated until the neon switches off for the first time. For any other types of cooking, a preheat may not be required.

Conventional oven

Preheating is always required

Manual Operation (fanned only)

The programmer must be set to manual operation before the main oven can be used. If A (Auto) is on the programmer display, return the oven to manual by pressing the up and down buttons simultaneously. Any programme which has been set is cancelled.

The cooling fan

The cooling fan may operate when the main oven is on and may continue to operate for a period after the oven has been switched off.

OVEN FURNITURE

Oven shelves

The oven shelf must be positioned with the upstand at the rear of the oven and facing upwards.

Position baking trays and roasting tins on the middle of the shelves.

Baking tray and roasting tins

For best cooked results and even browning, the recommended size baking trays and roasting tins that should be used are as follows;

Baking tray 350mm x 250mm

This size of baking tray will hold up to 12 small cakes.

Roasting tin 370mm x 320mm

We recommend that you use good quality cookware. Poor quality trays and tins may warp when heated, leading to uneven baking results.

USING THE MAIN OVEN - ELECTRIC

Slow cooking (S Setting or 100°C)

- Make sure that frozen foods are thoroughly thawed before cooking.
- Do not slow cook joints of meat or poultry weighing more than 2¼kg/4½lb.
- Preheat the oven to 170°C and cook for 30 minutes, then adjust the oven control to (S) or 100°C (slow cook setting) for the remainder of the cooking time.
- Slow cooking times will be about 3 times as long as conventional cooking times.
- Do not open the oven door unnecessarily during slow cooking, as this will result in heat loss at low temperatures.
- Always use dishes with tightly fitting lids. To rectify badly fitting lids, place foil over the dish underneath the lid.

Aluminium foil

Use foil only to cover food or cooking dishes, using foil to cover the shelves or oven base creates a fire hazard.

Cooking with a fanned oven

As this is a high efficiency oven, you may notice the emission of steam from the oven when the door is opened. Please take care when opening the door.

If you are used to cooking with a conventional oven you will find a number of differences to cooking with a fan oven which will require a different approach:

There are no zones of heat in a fan oven as the convection fan at the back of the oven ensures an even temperature throughout the oven.

This makes it ideal for batch baking - eg; when planning a party as all the items will be cooked within the same length of time.

Foods are cooked at a lower temperature than a conventional oven, so conventional recipe temperature may have to be reduced. Please refer to the conversion chart.

Preheating is generally not necessary as a fan oven warms up quickly.

There is no flavour transference in a fan oven, which means you can cook strong smelling foods such as fish at the same time as mild foods - eg; milk puddings.

When batch baking foods that will rise during cooking - eg; bread - always ensure that enough space has been left between the shelves to allow for the rise.

Notes:

When 2 or more shelves are being used, it may be necessary to increase the cooking time slightly.

Because the 2 oven shelves are wider than in many ovens, it is possible to cook 2 items per shelf - eg; 2 victoria sandwiches or 2 casseroles.

Although you need to keep in mind the points 'To help the air circulate freely' with careful choice of dishes and tins, it is possible to cook a complete meal, and perhaps something else for the freezer, in the oven at the same time.

When roasting meats, you will notice that fat splashing is reduced, which is due in part to the lower oven temperatures, and will help keep cleaning of the oven to a minimum.

Because a fan oven has an even temperature throughout the oven, there is no need to follow the shelf positions given in the baking guide.

USING THE MAIN OVEN - ELECTRIC

There is no need to interchange dishes onto different shelves part way through cooking, as with a conventional oven.

To help the air circulate freely

Position the shelves evenly within the oven and maintain a clearance from the oven roof and base.

If more than one cooking dish or baking tray is to be used on a shelf, leave a gap of at least 25mm between the items themselves and the oven interior.

Defrosting and cooling in the main oven

To defrost frozen foods, turn the main oven control to the defrost position, place the food in the centre of the oven and close the door.

To cool foods after cooking prior to refrigerating or freezing, turn the main oven control to the defrost position and open the door.

Defrosting times

Small or thin pieces of frozen fish or meat - eg; fish filets, prawns & mince will take approximately 1 - 2 hours.

Placing the food in a single layer will reduce the thawing time.

A medium sized casserole or stew will take approximately 3 - 4 hours.

A 1½kg/3lb oven ready chicken will take approximately 5 hours, remove the giblets as soon as possible.

Be safe

Do not defrost stuffed poultry using this method.

Do not defrost larger joints of meat and poultry over 2kg/4lb using this method.

Never place uncooked food for defrosting next to cooked food which is to be cooled, as this can lead to cross contamination.

Defrosting meat, poultry, and fish can be accelerated using this method but make sure they are completely thawed before cooking thoroughly. Place meat and poultry on a trivet in a meat tin.

MAIN OVEN BAKING GUIDE

Cooking times & temperatures

The temperature settings and times given in the baking guide are based on dishes made with block margarine. If soft tub margarine is used it may be necessary to reduce the temperature setting.

Allow enough space between shelves for food that will rise during cooking.

Do not place items on the oven base as this will prevent air circulating freely.



USING THE MAIN OVEN - ELECTRIC

Note: This is a high efficiency oven, therefore some adjustment will have to be made to conventional cooking temperatures. The table below shows conventional cooking temperatures, 'A' efficiency temperatures and gas marks. For optimum results,

conventional temperatures need to be converted to 'A' efficiency temperatures.

For example, an item which would normally cook at a conventional temperature of 180 °C, will now cook at the 'A' efficiency temperature of 160°C.

Conventional temperature (°C)	'A' Efficiency Oven (°C)	Gas Mark
100	100	1/4
110	110	1/4
130	120	1/2
140	130	1
150	140	2
160	150	3
180-190	160	4-5
200	170	6
220	180	7
230	190	8
250	200	9

Food Type	Temperature settings (°C)		Time Approx.	Shelf Position
Cakes	Conv 	Fanned 		
Small cakes	190	160	15 - 25	2 - 4
Victoria sandwich	180	160	20 - 30	3
Semi rich fruit cake	150	125	2.5HRS - 3HRS	2
Christmas cake	150	125	2.5HRS - 3HRS	2
Puddings				
Bread and butter pudding	170	150	45 - 1hr	3
Fruit crumble	200	175	40 - 1hr	3
Miscellaneous				
Yorkshire pudding: large	220	200	40 - 48	4 - 5
small	220	200	15 - 20	4 - 5
Shortcrust pastry	200	180	Depends on filling	4 - 5

USING THE MAIN OVEN - ELECTRIC

Traditional fruit cakes

It should be remembered that ovens can vary over time, therefore cooking times can vary, making it difficult to be precise when baking fruit cakes.

It is necessary therefore, to test the cake before removal from the oven. Use a fine warmed skewer inserted into the centre of the cake. If the skewer comes out clean, then the cake is cooked.

- Follow the temperatures suggested in the recipe and then adjust accordingly to the conversion table.
- Do not attempt to make Christmas cakes larger than the oven can cope with, you should allow at least 25mm (1") space between the oven walls and the tin.
- Always follow the temperatures recommended in the recipe.
- To protect a very rich fruit cake during cooking, tie 2 layers of brown paper around the tin.
- We recommend that the cake tin is not stood on layers of brown paper, as this can hinder effective circulation of air.
- Do not use soft tub margarine for rich fruit cakes, unless specified in the recipe.
- Always use the correct size and shape of tin for the recipe quantities.

Roast turkey

Roasting turkey involves cooking two different types of meat - the delicate light breast meat, which must not be allowed to dry out, and the darker leg meat, which takes longer to cook.

The turkey must be roasted long enough for the legs to cook, so frequent basting is necessary. The breast meat can be covered once browned.

- Always make sure that the turkey is completely thawed and that the giblets are removed before cooking.
- Turkey should be roasted at 160°C - 180°C (fanned) or 180°C - 200°C (conventional) for 20 minutes per 450g (1 lb), plus 20 minutes, unless packaging advises otherwise.
- The turkey can be open roasted, breast side down, for half of the cook time, and then turned over for the remainder of the cooking time.
- If the turkey is stuffed, add 5 minutes per 450g (1 lb) to the cooking time.
- If roasting turkey covered with foil, add 5 minutes per 450g (1 lb) to the cooking time.

To test if the turkey is cooked, push a fine skewer into the thickest part of the thigh. If the juices run clear, the turkey is cooked. If the juices are still pink, the turkey will need longer cooking.

USING THE MAIN OVEN - ELECTRIC

Roasting guide

The times given in the roasting guide are only approximate, because the size and age of the bird will influence cooking times as will the shape of a joint and the proportion of the bone.

Frozen meat should be thoroughly thawed before cooking. For large joints it is advisable to thaw over night.

Frozen poultry should be thoroughly thawed before cooking. The time required depends on the size of the bird - eg; a large turkey may take up to 48 hours to thaw.

Use of a trivet with a roasting tin will reduce fat splashing and will help to keep the oven interior clean. Alternatively, to help reduce fat splashing, potatoes or other vegetables can be roasted around the meat/poultry.

Notes:

- When cooking stuffed meat or poultry calculate the cooking time from the total weight of the meat plus the stuffing.
- For joints cooked in foil or covered roasters, and for lidded casseroles, add 5 minutes per 450g (1lb) to the calculated cooking time.
- Smaller joints weighing less than 1.25kg (2½lb) may require 5 minutes per 450g (1lb) extra cooking time.
- Position the oven shelf so that the meat or poultry is in the centre of the oven.
- It is recommended that the appliance is cleaned after open roasting.

Cook in main oven at: 160°C - 180°C (fanned) 180°C - 200°C (conventional)		Approximate Cooking Time (preheated oven)
Beef	Rare Medium Well done	20 minutes per 450g (1lb), plus 20 minutes 25 minutes per 450g (1lb), plus 25 minutes 30 minutes per 450g (1lb), plus 30 minutes
Lamb	Medium Well Done	25 minutes per 450g (1lb), plus 25 minutes 30 minutes per 450g (1lb), plus 30 minutes
Pork		35 minutes per 450g (1lb), plus 35 minutes
Poultry		20 minutes per 450g (1lb), plus 20 minutes

USING THE CLOCK/PROGRAMMER-ELEC(IF FITTED)

THE ALTERNATIVE PROGRAMMERS

There are two types of programmer covered in this section - push button & touch control. Both programmers have the same symbol variants & functions but may vary in their method of operation.

The push button programmer

Symbol	Symbol	What is it?
∨	—	<p>Down/minus</p> <p>Used to decrease cook / end time, remove minutes from the minute minder and adjust the time of day. Also for listening to and setting the alarm tone.</p>
∧	+	<p>Up/plus</p> <p>Used to increase cook / end time, add minutes to the minute minder and adjust the time of day.</p>
<p>FUNCTION or</p> 	MODE	<p>Function button</p> <p>Used to select the functions available on this timer.</p> <p>Press once for: Minute Minder. Press twice for: Cook time Press three times for: End time.</p> <p>How to use these functions is explained later on in this section.</p>

The 'function' button in the centre is used for setting the minute minder and setting up the automatic cooking. See below for details.

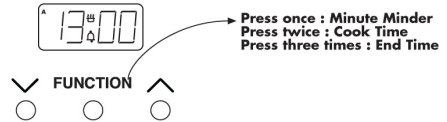

Symbols on the LED display.

This 'A' symbol appears when either a semi, or fully automatic program is selected. This symbol will flash while a program is being set.

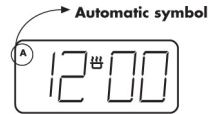

Once a program is set the symbol will light up, and remain lit until the alarm sounds, or the program is cancelled.

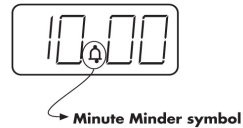

This bell symbol appears when the Minute Minder function has been selected.

While the Minute Minder is being set, the Bell symbol flashes. Once the length of time is set, the Bell symbol remains lit until the time runs down, or the function is cancelled.



This message and 'A' symbol appear when you are asked to set the length of time you require the oven to cook automatically for. Using the Up and Down buttons adjusts this accordingly.



This message

USING THE CLOCK/PROGRAMMER-ELEC(IF FITTED)

and 'A' symbol appear when you are asked to enter in an end time, or when you would like the oven to switch itself off.

To set the time of day

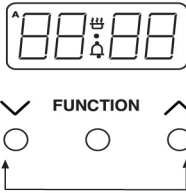

- Press the Up and Down buttons together for a few seconds, and release.
- The '•' in between the numbers on the LED Display will begin to flash.
- While the '•' is flashing it is possible to adjust the time using the Up and Down buttons. Once the time has been set, allow approximately 30 seconds before using any of the other timer functions. This ensures that the time will remain correct.

To select an alarm tone

There are three tones to choose from.

- Press and hold the down button to listen to the first tone.
- Release the down button and press it again to listen to the second tone etc.
- Releasing the down button after the tone has sounded will automatically select that tone.

Setting the minute minder

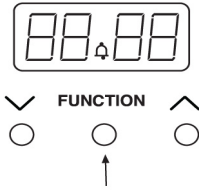

- To set the Minute Minder, press the Function button once. The bell symbol will appear and start flashing. The flashing only lasts for 5 seconds so the time must be set within this time frame.
- Use the Up and Down button to set the length of time required. Once this has been done, the Minute Minder is set.
- When the desired length of time has counted down the alarm will sound.
- To cancel the tone, press any of the buttons.
- To cancel the Minute Minder at any time, press the Up and Down buttons together.

USING THE CLOCK/PROGRAMMER-ELEC(IF FITTED)

Semi-automatic cooking

There are two types of semi automatic cooking available on this appliance.

The oven must be switched on, and in use to use either of these functions successfully.

The Duration method allows you to set the oven for a specific length of time. If a dish needed 2 hours to cook, then it would be possible for you to set the oven to turn off 2 hours later. This allows you to be sure that your food will be cooked for a set length of time and no longer.

The End Time method allows you to enter a specific time when you would like the oven to switch off. If you wish to leave the oven unattended, then it offers peace of mind that the oven will have turned itself off at the set time.

However, once the program is set then it cannot be adjusted. Extra time cannot be added, nor can the end time be extended.

To cancel the semi automatic programs, press both the Up and Down buttons together. This can be done at any time during the cooking process. Then if necessary, re program.

For the instructions on how to use both of these functions, please see the following page.

Fully automatic cooking

This function incorporates both a duration and an end time and is meant to be used when you wish to delay the start time.

We recommend that the first few times this function is used you are in the house, this will familiarise you with your oven and prevents food from being over cooked or under cooked.

Care must be taken when selecting foods for this function, it is not recommended for certain food items which may spoil, or are sensitive to being left.

It is also advisable to set the end time to be as close to your return as possible to prevent food being left standing.

USING THE CLOCK/PROGRAMMER-ELEC(IF FITTED)

SEMI-AUTOMATIC COOKING

The duration method

- Press the Function button twice,(1) which will skip past the Minute Minder.
- The LED display will flash the word 'dur', (2) and the 'A' will flash on the left hand side of the display.
- Use the Up and Down buttons to set the length of time you want to cook for.(3) This must be done within 5 seconds or the time of day will show again.

Once this is done the oven will automatically switch off once the time has elapsed, and the alarm will sound.

To switch off the alarm, press any button.
To view any remaining time press the function button twice.

The end time method

- Press the Function button three times, which will skip past the Minute Minder and the Duration programmer. (4)
- The LED display will flash the word 'End' and the 'A' will flash on the left hand side of the display. (5)
- Use the Up and Down buttons to select the time the oven is required to turn off. (6)

Once this is done the oven will turn itself off at the time you have selected.

To switch off the alarm, press any button.

1. The Duration method

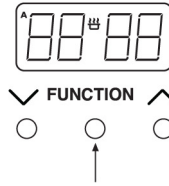

2.



3.

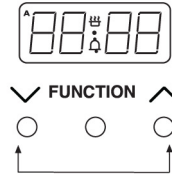

4. The End Time method

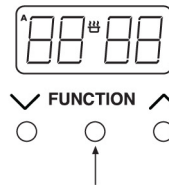

5.



6.

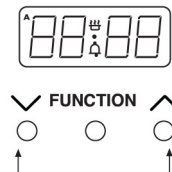

USING THE CLOCK/PROGRAMMER-ELEC(IF FITTED)

FULLY AUTOMATIC COOKING (EXAMPLE)

This programming method is best suited for when a delayed start time is required. Unlike the semi automatic methods this requires both the duration and the end time to be entered. The timer will work out the start time and begin cooking.

- Press the function button twice to select the length of time your food will need. (7)
- The 'A' on the left hand side will flash and the 'dur' message will flash up. (8)
- Using the Up and Down buttons set the time you require within 5 seconds of the 'dur' message. (9)
- Press the function button three times until the 'A' flashes again and the 'End' messages appears. (10) & (11)
- Using the Up and Down buttons, set the time you would like the oven to switch off. (12)
- Set the temperature of the oven and place the food inside.

While the automatic function is running, the 'A' will appear statically on the display, with the time.

Try to keep the end time as close to when you expect to return, this will prevent cooked food from being left standing in a warm oven.

The timer will calculate the appropriate start time.

To switch off the alarm, press any button.

7

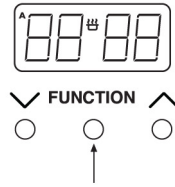

8



9

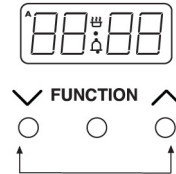

10

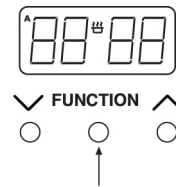

11



12

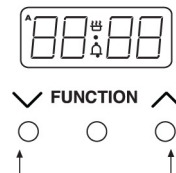

USING THE CLOCK/PROGRAMMER-ELEC(IF FITTED)

The touch control programmer

There are three touch control icons for this timer - the table below shows you what the symbols look like, depending on the model type, & their functions.

Note - some functions require you to 'touch & hold' an icon for a few seconds, whilst others require you to just 'touch' the icon without holding.

The 'function' icon in the centre is used for setting the minute minder & setting up the automatic cooking - see below for details.

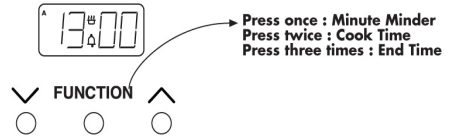

Sym- bol	Sym- bol	What is it?
∨	-	Down/minus Used to decrease cook / end time, remove minutes from the minute minder and adjust the time of day. Also for listening to and setting the alarm tone.
∧	+	Up/plus Used to increase cook / end time, add minutes to the minute minder and adjust the time of day.
FUNC- TION	MODE	Function icon Used to select the functions available on this timer. Touch once for: Minute Minder. Touch twice for: Cook time Touch three times for: End time. How to use these functions is ex- plained later on in this section.

Symbols on the LED display.

This 'A' symbol appears when either a semi, or fully automatic program is selected. This symbol will flash while a program is being set.

Once a program is set the symbol will light up, and remain lit until the alarm sounds, or the program is cancelled.

This Bell symbol appears when the Minute Minder function has been selected.

While the Minute Minder is being set, the Bell symbol flashes. Once the length of time is set, the Bell symbol remains lit until the time runs down, or the function is cancelled.

This message and 'A' symbol appear when you are asked to set the length of time you require the oven to cook automatically for. Using the Up and Down icons adjusts this accordingly.

This message and 'A' symbol appear when you are asked to enter in an end time, or when you would like the oven to switch itself off.

USING THE CLOCK/PROGRAMMER-ELEC(IF FITTED)

Setting the time of day

Touch & hold the centre (function) icon for a few seconds until the ● symbol between the numbers on the LED display flashes.

While the ● symbol is flashing, you can adjust the time of day by touching the plus & minus icons. Please note: the hours & minutes adjust quickly.

Important - once the time of day has been set, allow approximately 30 seconds before using any of the other programmer functions. This ensures that the time of day will remain correct.

Setting an alarm tone

Touch & hold the plus & minus icons simultaneously until the ● symbol flashes & you hear a beep - then touch the centre (function) icon.

Touch the minus icon to select the tone.

You can change the tone by repeatedly touching the minus icon - there are three tones to choose from.

Setting the minute minder

To set the minute minder, touch & hold the centre (function) icon until the bell symbol appears & begins to flash. Important - the flashing will last for approximately five seconds, so any setting must be carried out within this time frame.

Touch the plus & minus icons to set the length of time required. Once this has been done, the minute minder is set.

When the desired length of time has counted down, the alarm will sound. To cancel the tone, touch & hold any of the icons.

To cancel the minute minder at any time, touch & hold the plus & minus icons together.

Semi-automatic cooking

Method 1 - duration (switch off after set time period):

Touch & hold the centre (function) icon; the bell will flash & you will hear a beep. Touch the centre (function) icon again - this will skip past the minute minder function.

The display will flash the word 'dur' & the 'A' will flash on the left hand of the display.

Use the plus & minus icons to set the length of time you want to cook for. The flashing will last for approximately five seconds, so the setting must be done within this time frame or the time of day will show again.

Once the duration has been set, the oven will automatically switch off. When the set time has elapsed the alarm will sound. To switch the alarm off, touch any icon.

To view any remaining time, touch & hold the centre (function) icon & touch again.

To cancel the semi-automatic programme at any time, touch the plus & minus icons together.

Method 2 - end time (switch off at a set end time):

Touch & hold the centre (function) icon; the bell will flash & you will hear a beep. Touch the centre (function) icon again - twice - this will skip past the minute minder & duration functions.

The display will flash the word 'End' & the 'A' will flash on the left hand of the display.

USING THE CLOCK/PROGRAMMER-ELEC(IF FITTED)

Use the plus & minus icons to select the time the oven is required to switch off.

Once this is done the oven will switch itself off at the pre-selected time. To turn the alarm off, touch any icon.

To cancel the semi-automatic programme at any time, touch the plus & minus icons together.

Fully automatic cooking

This function allows the cooker to switch on & off automatically. It requires both the duration & the end time to be entered. The timer will work out the start time & begin cooking.

Touch & hold the centre (function) icon; the bell will flash & you will hear a beep. Touch the centre (function) icon again - this will skip past the minute minder function.

The display will flash the word 'dur' & the 'A' will flash on the left hand of the display.

Use the plus & minus icons to set the length of time you want to cook for. The flashing will last for approximately five seconds, so the setting must be done within this time frame or the time of day will show again.

Touch the centre (function) icon again - this skips past the minute minder & duration functions.

The display will flash the word 'End' & the 'A' will flash on the left hand of the display.

Use the plus & minus icons to select the time the oven is required to switch off.

Set the temperature of the oven & place the food inside. The timer will calculate the start time.

When this is done the oven will turn itself off at the time you have selected. To switch off the alarm, touch any icon.

To cancel the automatic programme at any time, touch the plus & minus icons together.

CLEANING

General

- It is important to clean the product regularly as a build up of fat can affect its performance or damage it and may invalidate your guarantee.
- Always switch off your appliance and allow it to cool down before you clean any part of it.
- Do not use undiluted bleaches, products containing chlorides, wire wool or abrasive cleaners on aluminium, stainless steel, or plastic/painted parts as they can damage the appliance. Nylon pads can also be unsuitable.
- Take extra care when cleaning over symbols on fascia panels. Excessive cleaning can lead to the symbols fading.
- If your product is fitted with stainless steel cladded stips. You may notice a small white residue on the outer edges, this can be removed with a non abrasive wipe.

Painted & Plastic parts

- Only use a clean cloth wrung out in hot soapy water.
- Do not use abrasive cleaners, wire or nylon cleaning pads on these parts.

Stainless steel & Aluminium surfaces

- Only use a clean cloth wrung out in hot soapy water, and dry with a soft cloth.
- Stubborn marks can be removed using a stainless steel cleaner. Supplies can be purchased from the Customer Care Centre.
- Sharp objects can mark the surface of stainless steel, but will become less noticeable with time.
- Wipe any spillage immediately, taking care to avoid burning your hands

- Some foods are corrosive eg; vinegar, fruit juices and especially salt - they can mark or damage the metal if they are left on the surface.
- Baby oil can be used to restore stainless steel finishes - but only use a few drops. Don't use cooking oils as they can contain salts, which will damage the metal.
- Do not use steam cleaners.

Enamel surfaces & parts

- Clean with warm, soapy water and a clean cloth.
- If larger splashes of fat do not readily disappear, you can use a mild cream cleaner to remove them. More stubborn marks can be removed using a soap filled pad.
- Rinse well and dry with a soft clean towel or cloth.
- Do not use steam cleaners.

Glass parts

WARNING:- Do not use harsh abrasive cleaners or sharp metal scrapers to clean the oven door glass since they can scratch the surface, which may result in shattering of the glass.

- Only use a clean cloth wrung out in hot soapy water, or a specialist glass cleaner.

Rinse away any excess cleaner and dry with a soft cloth.

Chrome plated parts

- Use a moist soap filled pad, or place in a dishwasher

CLEANING

REMOVING OVEN PARTS FOR CLEANING

Inner Door Glass (glass doors only)

- The inner door glass panel can be removed for cleaning but it must be replaced the right way up. If there is any writing on the glass, you must be able to read it clearly when the cavity doors are open.
- Always make sure that the glass is pushed fully into the Stop position.
- To remove the glass panel, open the door wide, hold the top and bottom edges and slide out.
- **Warning:** Do not operate the appliance without the glass panel correctly fitted.
- For your safety, glass door panels are made of toughened glass. This ensures that, in the unlikely event that a panel breaks, it does so into small fragments to minimise the risk of injury. Please take care when handling, using or cleaning all glass panels, as any damage to the surfaces or edges may result in the glass breaking without warning or apparent cause at a later date. Should any glass panel be damaged, we strongly recommend

that it is replaced immediately.

Shelf Runners

- Shelf runners can be removed to enable you to clean them thoroughly. Make sure they are cool to touch and then grasp the runners and slide out of their hanging holes.

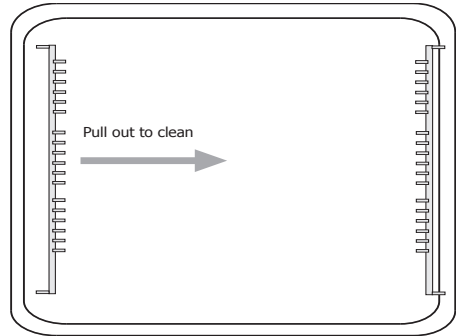

CLEANING

TELESCOPIC SHELVING SYSTEM (if fitted)

- In addition to the traditional shelving fitted in your appliance, the telescopic shelving system is fitted in the most commonly used location in your cavity.
- The shelves with the telescopic system are easier to pull out than traditional shelving, which means the oven door stays open for a shorter period of time. The smooth action also reduces the likelihood of fat, or food, spillage, and gives you extra security.
- You do not have to use the telescopic shelves all of the time. You can place the shelves in the traditional positions if you would like more choice.
- The telescopic shelves remove easily from the runner for re-positioning or cleaning, but we recommend that you reposition your shelving before cooking, and remove the shelving for cleaning when the shelves are cold to prevent burning yourself.

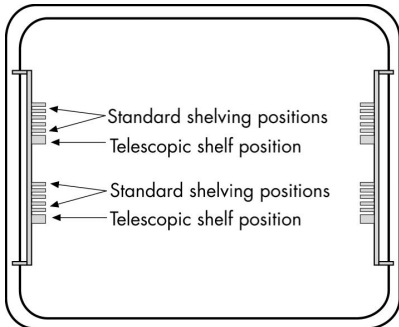

To remove the telescopic shelves

- Make sure the shelf is cool enough to touch.
- Push the oven shelf back into the cavity, until it hits the stop position.
- Grasp the shelf bars in the centre, and lift the back of the shelf clear of the stop position.
- You can then lift the front of the shelf clear of the retaining tabs.

To replace the telescopic shelves

- Make sure the oven runners are pushed all the way back into the cavity.
- Tilt the shelf and make sure the front of the shelf is against the stop position.
- Carefully place the shelf back onto the runner and snap in place firmly.
- Make sure the back of the self is inside the retaining tabs and slide it in and out of the oven to make sure it works correctly.

Make sure the shelf is firmly pressed against the stop position at back of the oven cavity

Note: Make sure the shelf is unclipped from the retaining tabs before removal.

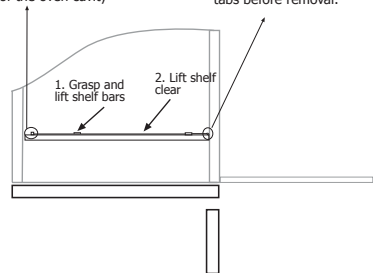

CLEANING

GAS HOB

Burner caps and heads

- The slots in the burner head where the flames burn should be cleared of deposits.
- Clean with a nylon brush, rinse and then dry thoroughly. There may be brown coloured markings on your burners; these are carbon deposits or fat stains and can be removed using a soap filled pad.
- Do not put burners in the dishwasher or soak them. Using dishwasher powders, washing up liquids and caustic pastes can damage the burners.
- Burner caps and heads must be repositioned correctly so that they sit squarely on to the hob as shown. This is particularly important with stainless steel models as failure to reposition the caps correctly may result in discolouration of the stainless steel around the burners.

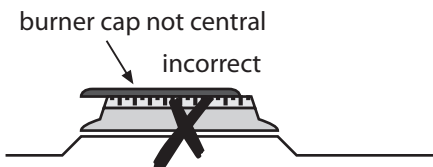
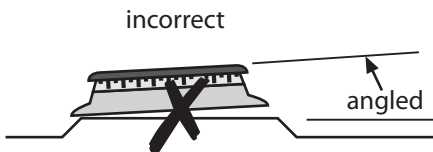
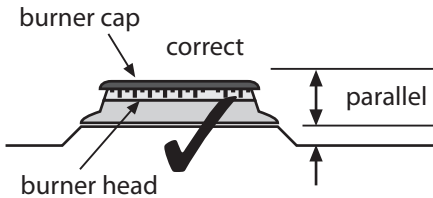

Cast iron griddle or pan supports (if fitted)

- Ensure the griddle has fully cooled and scrape off any stubborn marks and bits of food with a plastic or wooden cooking implement. Rinse in warm soapy water and dry with a tea towel.
- Do not clean in a dishwasher.
- If you notice any rusting on your griddle, or pan-supports, simply clean in warm soapy water, then re-season.
- To season: Heat the griddle for 30 seconds at a medium setting then switch off. Use a minimum amount of unsalted vegetable oil, on a dry cloth or paper towel, and apply a thin coat of oil to the element surface. Wipe off the excess and re-heat the griddle for one minute.

INSTALLATION INSTRUCTIONS - DUAL FUEL

Before you start: Please read the instructions. Planning your installation will save you time and effort.

Prior to installation, ensure that the local distribution conditions (nature of the gas and gas pressure) and the adjustment of the appliance are compatible. The adjustment conditions are stated on the data badge.

This appliance is not connected to a combustion evacuation device. It shall be installed and connected in accordance with current installation regulation. Particular attention shall be given to the relevant requirements regarding ventilation.

In your own interest and that of safety, it is the law that all gas appliances be installed and serviced by competent persons. GAS SAFE registered installers undertake to work to satisfactory standards.

Where regulations or standards have been revised since this handbook was printed, always use the latest edition.

In the UK the regulations and standards are as follows:

1. Gas Safety Regulations 1996 (Installation and Use).
2. Building Regulations - Issued by the Department of the Environment.
3. Building Standards (Scotland) (Consolidated) - Issued by the Scottish Development Department.
4. The current I.E.E. Wiring Regulations.
5. Electricity at Work Regulations 1989.
6. BS 6172 Installation of Domestic Gas cooking Appliances.
7. Installation & Servicing Instructions for this appliance.

For installation in countries other than the UK, the appliance must be connected in accordance with all local gas and electrical regulations. In the Republic of Ireland, Installers should refer to IS813 Domestic Gas Appliances.

Ventilation requirements

The use of a gas cooking appliance results in the production of heat and moisture in the room in which it is installed. Ensure that the kitchen is well ventilated: keep natural ventilation holes open or install a mechanical ventilation device (mechanical extractor hood). Prolonged intensive use of the appliance may call for additional ventilation, for example, opening of a window, or more effective ventilation, for example increasing the level of mechanical ventilation where present.

The room containing the appliance should have an air supply in accordance with BS 5440: Part 2: 1989:

All rooms require an openable window, or equivalent, and some rooms will require a permanent vent as well.

For room volumes up to 5m^3 an air vent of 100cm^2 is required.

If the room has a door that opens directly to the outside, or the room exceeds 10m^3 , NO AIR VENT is required.

For room volumes between 5m^3 and 10m^3 an air vent of 50cm^2 is required.

If there are other fuel burning appliances in the same room, BS 5440: Part 2: 1989 should be consulted to determine the air vent requirements.

This appliance must not be installed in a bed sitting room of less than 20m^3 or in a bathroom or shower room.

INSTALLATION INSTRUCTIONS - DUAL FUEL

Windows and permanent vents should therefore not be blocked or removed without first consulting a GAS SAFE gas installer.

In the Republic of Ireland, refer to relevant Irish Standards for correct ventilation requirements.

Failure to install appliances correctly is dangerous and could lead to prosecution.

Whilst every care is taken to eliminate burrs and raw edges from this product, please take care when handling - we recommend the use of protective gloves during installation.

Moving the cooker

Please note that the weight of this appliance is approximately 60kg (unpacked). Take care if the appliance needs to be lifted during installation - always use an appropriate method of lifting.

Do not attempt to move the cooker by pulling on the doors or handles. Open the door and grasp the frame of the cooker, taking care that the door does not shut on your fingers. Take care to avoid damage to soft or uneven floor coverings when moving the appliance. Some cushioned vinyl floor coverings may not be designed to withstand sliding appliances without marking or damage.

CLEARANCES & DIMENSIONS

Appliance dimensions

All sizes are nominal - some variation is to be expected. The 'depth' of the cooker, as given below, is to the front of the door & excluding knobs & handles.

depth: 600mm
width: 500/550/600mm
height - lid down: 900 - 915mm
height - lid raised: 1430 - 1445mm

Clearances

No shelf or overhang or cooker hood should be closer than a minimum of 650mm, but check with cooker hood manufacturer's recommendations.

The cooker must have a side clearance above hob level of 90mm up to a height of 400mm.

This cooker may be fitted flush to base units. However, for models with side opening doors, we recommend a side clearance of 60mm between the cooker and any side wall.

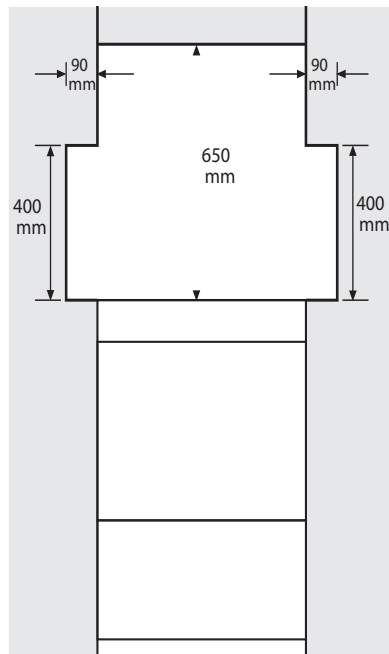

INSTALLATION INSTRUCTIONS - DUAL FUEL

LEVELLING YOUR COOKER

Place a spirit level on a baking sheet onto an oven shelf.

The cooker is fitted with LEVELLING FEET. Level your cooker to your desired height using the levelling feet at the front and rear of the cooker.

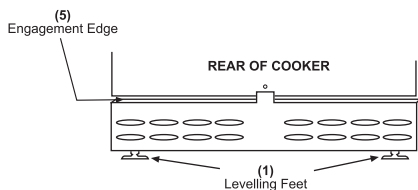

STABILITY BRACKET

If the cooker is fitted with a flexible connection, a stability bracket should be fitted to engage in the back of the cooker. A stability bracket can be bought from your local supplier.

A stability bracket can be fitted as follows:

Place the cooker in position and draw a PENCIL LINE level with the front edge (2).

Mark the centre of the cooker to give a CENTRE LINE (3).

Remove the cooker and mark off 200mm to the right of the centre line (4) on the rear wall.

Measure from FLOOR LEVEL to the ENGAGEMENT EDGE where the stability bracket will rest and add 2mm (5).

Transfer this dimension to the rear wall and secure the bracket to the wall at this height (6) using the two off centre holes in the single bracket.

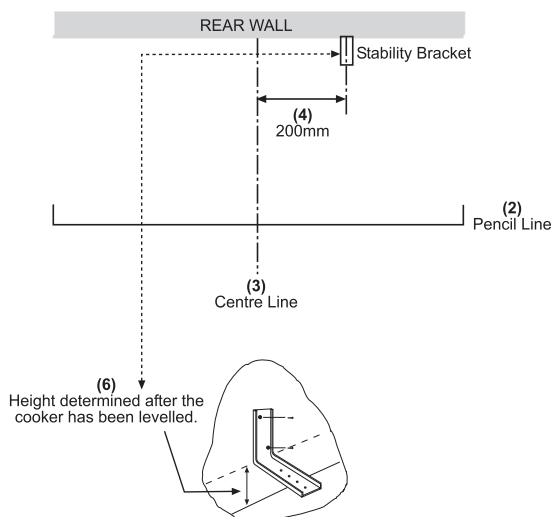

INSTALLATION INSTRUCTIONS - DUAL FUEL

PRODUCTS WITH CAST IRON LID (WHERE FITTED)

A 55mm clearance is required from the back of the hotplate to the rear wall, to allow the lid to be opened fully. To ensure this clearance is maintained, the infill piece (supplied) should be fitted using the instructions below.

Fix the infill piece to the wall - using suitable screws and wall fixings (not supplied) - and ensure it is level with the hotplate as shown.

Note: The 55mm clearance dimension should not be reduced.

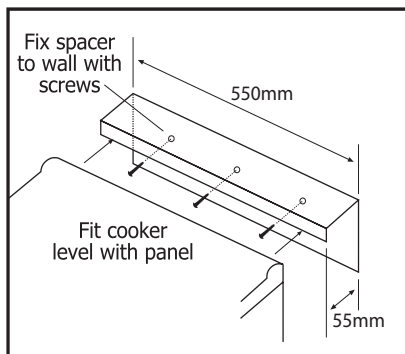

INSTALLATION INSTRUCTIONS - DUAL FUEL

CONNECT TO THE ELECTRICITY SUPPLY

Warning: This appliance must be earthed.

The appliance must be installed by a competent electrician using a double pole control unit of 32 ampere minimum capacity with 3mm minimum contact separation at all poles.

We recommend that the appliance is connected by a qualified electrician who is a member of the N.I.C.E.I.C. and who will comply with the I.E.E. and local regulation.

1. Access to the mains terminal is gained by opening the terminal block cover at the rear of the appliance (use a small flat-bladed screwdriver).
2. Connection should be made with 6.0mm² flexible twin and earth cable.
3. First strip the wires, then push the cable through the cable clamp in the terminal block cover.
4. Connect the cable to the terminal block and tighten the cable clamp screw (see diagram).
5. Close the terminal box, ensuring that the cover is engaged on the locking tabs.

Your appliance will be fitted with one of the two terminal blocks below, Block A, Block B

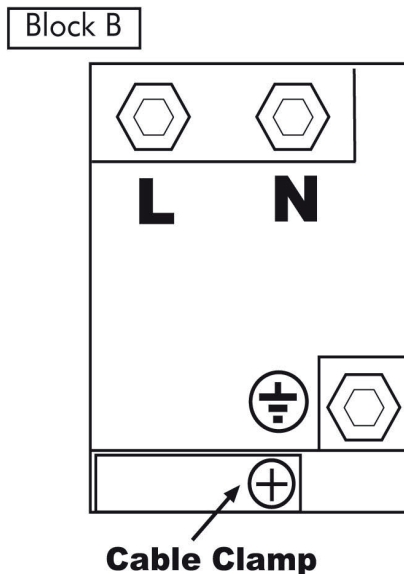
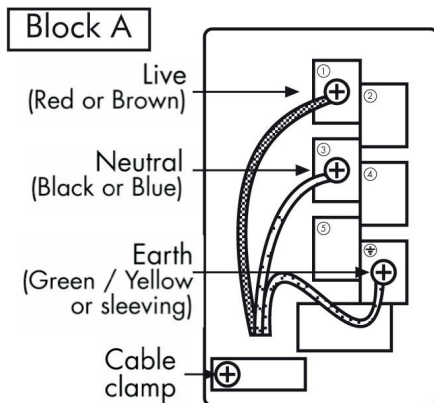

INSTALLATION INSTRUCTIONS - DUAL FUEL

CONNECT TO THE GAS SUPPLY

The inlet to the cooker is ½" BSP internal situated at the rear right corner. Fit the bayonet connection. This should be located so as to ensure that the flexible connector hose does not kink.

Under no circumstances should the flexible connector be allowed to come into contact with the vertical oven flue tubes on the rear of the appliance.

Use a 900mm - 1125mm length of flexible connector.

Ensure that all pipework is of the correct rating for both size and temperature.

Natural Gas - Flexible connections should comply with BS 669. Parts of the appliance likely to come into contact with a flexible connector have a temperature rise of less than 70°C.

After installation, make sure all connections are gas sound.

COMMISSIONING

Burner aeration

All burners have fixed aeration and no adjustment is possible.

Hob burner

Turn the control knob to the FULL ON position, wait a second before pressing the ignition switch or holding a lighted match or taper to the burner. Hold the control knob in for 15 seconds. Do not hold the control knob in for longer than 15 seconds. If the burner fails to light within this time, release the control knob and wait one minute before attempting further ignition.

Check the operation of electrical components, viz;

Clock programmer/ Minute minder

Check functions as described earlier in this booklet.

Oven light & convection fan

Open the main oven door. Turn the main oven control knob to the defrost setting . . . , check the oven light and convection fan both come on. Turn control knob back to off position.

Cooling fan

Open the grill door. Turn the grill control knob to the full power setting Check that the cooling fan operates. Turn control knob back to off position and check cooling fan switches off immediately.

Lid safety system (if fitted)

Ignite all hotplate burners including wok. Attempt to close the lid and make sure all flames are extinguished by the safety system.

If you are satisfied that the cooker is operating correctly, turn it off and show the customer how to use it. Make sure you ask the customer to operate the clock (if fitted) and controls.

Explain to the user that the lid safety system must not be used as a means of turning off the hotplate burners. Control knobs must always be turned to the off position after use.

Note- If the cooker does not perform correctly, inform the customer of the problem and put a warning notice on the cooker. If the problem is dangerous, then disconnect the cooker. If there is a fault, then the customer should be advised to contact the manufacturer's local service organisation or the retailer.

Before leaving the installation hand over the handbook to the customer.

Thank you.

TECHNICAL DATA

DUAL FUEL PRODUCTS

Data badge - Lower part of front frame

Type of gas - This cooker can be used with Natural Gas and LP Gas

Gas category - Natural Gas - II2H 3+

Pressure setting

G20 Natural Gas @ 20 mbar

LP GAS G30 @ 29MBAR

G31 @ 37mbar

Aeration - Fixed

Appliance class - Class 1, freestanding

Grill - Electric

Hob - Burners have burner heads and caps which are removable for cleaning. Concealed electrodes to each burner.

Electrical supply/load

220 - 240V ~ 50Hz

4135 - 4920 W

Warning: This appliance must be earthed.

Countries of Destination:

GB - IE - NL - FR

Gas	Burner	Nominal Rate QN	Injector Size
Natural Gas	Hob - small	1.0kW	77
	Hob - medium	1.9kW	104
	Hob - wok	4.0kW	152
	Max. heat input	ΣQn 8.80kW	

CUSTOMER CARE

FAQs

What parts of the appliance can be washed in a dishwasher?

- Any enamelled parts such as the grill-pan can be cleaned in a dishwasher, as can oven shelves and shelf guides.

What parts must NOT be cleaned in a dishwasher?

- Parts such as burner skirts and caps, control knobs and any cast iron items must not be cleaned in a dishwasher, they should be cleaned with hot soapy water and a nylon brush once they are cool enough.

There's been a power failure and the product won't work.

- Switch off the electricity supply.
- When the power returns switch the electricity supply back on and re-set any programmer/clock to the correct time of day.

My oven is a single combined oven and grill - can I use both functions together?

- No. You can only use one or the other.

Why is there condensation on the doors?

- Condensation is caused by hot, moist air meeting a cooler surface (i.e. the oven door). You cannot always prevent it, but you can minimise it when it happens by doing the following:
- Pre-heat the oven at a high temperature before putting food in the oven, and cover the food you are cooking wherever possible.
- Whenever you can, cook wet foods at higher temperatures.
- Don't leave food in the oven to cool down.
- Automatic cooking will normally produce condensation when the oven is

cooling down with food inside.

Should the cooling fan continue to run once the appliance has been switched off?

- Yes. This is to make sure that you can always touch the control knobs to make temperature adjustments, and turn your appliance off.

What is a Multifunction oven?

- A multifunction oven combines a variety of features, which are explained fully earlier in this book (if fitted), it allows you more flexibility when cooking.

The neon on my appliance keeps going out and coming back on again - is this right?

- Yes. In most cases the neon (if fitted) will cycle on and off to show that oven is maintaining your temperature choice.

Can all gas appliances be converted from Natural Gas to LP Gas?

- Not all gas appliances can be converted. If Category II is stated on the databadge, then the appliance may be converted and a conversion kit must be obtained if not already provided. If in doubt, please contact Customer Care for further advice - do not attempt to convert an appliance if it is not compatible.

Why won't the ignition work?

- Check there is a spark when the ignition button is depressed. If there is no spark, check the electricity supply is switched on at the socket. Check that the gas supply is switched on.

Call Customer Care for a Service Engineer's visit if:

- You find that the oven becomes hotter at a particular temperature - the thermostat may need replacing.
- The cooling fan fails to work.

CUSTOMER CARE

CUSTOMER CARE WEB SHOP

Having purchased a superior cooker, hob or hood from us, you'll naturally want to keep it looking great. And who better to help you care for it than the manufacturer?

We offer an extensive range of accessories, components and cleaning products which, will instantly give your cooker a good as new look.

In addition to the list of our most popular products below, we also have an exciting

range of Bake ware and Cookware essentials including Roasting Pans, Cake Tins and Non-Stick Cooking Liners.

For all enquires, please visit our Web Shop at www.gdhaonline.co.uk or call the Spares Sales Team on **0844 815 3745**. For countries outside the UK, please contact your local service agent.

Product Description	Where used	Purpose
Ceramic Hob Cleaner	All Ceramic glass hobs including Induction	Enables easier cleaning of your ceramic hob. Prevents build up of mineral deposits. Best used with Ceramic Hob Scraper Kit. 300ml bottle.
Ceramic Hob Scraper kit	All Ceramic glass hobs including Induction	Ideal for removing cooked on marks from ceramic glass hobs Best used with Ceramic Hob Cleaner
Sealed Hotplate Conditioner	All sealed/solid plate hobs	Restores the sleek matt black finish to solid hotplates
Multipurpose Kitchen Cleaner	General kitchen cleaner	Excellent multipurpose cleaner, For use around the kitchen. 500ml bottle.
Oven Cleaner	All cooking appliances.	Cuts through grease & burnt on grime. 500ml bottle
Restor-A-Cloth	All cooking appliances.	Chemical free cleaning cloth Ideal for cleaning & polishing glass & stainless steel
Stainless Steel Cleaner	All stainless steel parts	Oil based cleaner. Perfect for removing stubborn & greasy marks. 300ml bottle.
Rectangular carbon filters	Cooker Hoods	New filters, help to maintain efficient cooker hood operation and keep your Kitchen odour free
Round Carbon Filters	Cooker Hoods	New filters, help to maintain efficient cooker hood operation and keep your Kitchen odour free

CUSTOMER CARE

CHANGING LIGHT BULBS (where fitted)

Warning: There is a risk of electric shock, so always make sure you have turned off and unplugged your appliance before starting. Always allow the product to cool down before you change a bulb.

Not all appliances have the same number and type of bulbs. Before replacing your bulb, open the oven door and see which type you have. Then use the table to help you change your bulb correctly.

Bulbs can be purchased from hardwarestores (always take the old bulb with you).

Please remember that bulbs are not covered by your warranty.

No of Lamps	Instructions
1	Remove the oven shelves. Remove the loose oven back by unscrewing the 4 securing screws (one at each corner) and remove (Where fitted). Unscrew the lens cover by turning anticlockwise. Remove the bulb and replace. Replace the lens cover and oven back.

Please keep this handbook for future reference, or for anyone else who may use the appliance.

Please keep this handbook for future reference, or for anyone else
who may use the appliance.

Please keep this handbook for future reference, or for anyone else
who may use the appliance.

CUSTOMER CARE

To contact Stoves about your appliance, please call

Warranty Registration

0844 481 0182

to register your appliance

Customer Care Helpline

0844 815 3740

in case of difficulty within the UK

Alternatively general, spares and service information is available from our website at
www.stoves.co.uk

Please ensure that you have the product's model no and serial no available when you call. These can be found on the silver data label on your product which is located:

Ovens	Open the door; adjacent to the oven cavity
High-level grill products	Inside the base compartment
Hobs	On the underside of the product

Enter appliance numbers here for future reference:

Model No

--	--	--	--	--	--	--	--	--	--

Serial No

--	--	--	--	--	--	--	--	--	--

SERVICE RECORD

Date of purchase	Installed by	Installation Date
Place of purchase:		

Date	Part(s) replaced	Engineer's name

For customers outside the UK and Northern Ireland, please contact your local supplier.

Glen Dimplex Home Appliances, Stoney Lane, Prescot, Merseyside, L35 2XW